

The logo for KYRYA, featuring a stylized 'K' icon followed by the word 'KYRYA' in a bold, sans-serif font with a registered trademark symbol.A complex, abstract background composed of overlapping geometric shapes in various colors (brown, purple, orange, teal, blue) and textures (wood grain, dotted patterns, solid colors). The shapes are arranged in a dynamic, layered fashion, creating a sense of depth and movement.

PRICE LIST  
SPECIFICATIONS **2022**  
15/03

A small logo consisting of the letters 'UK' inside a square border.



KYRYA® is a leading company in the manufacture of bespoke and custom bathroom furniture. We are non-conformists and work with the motivation to continue developing our ability to generate new concepts and build partnerships with new ideas that result in innovative and attractive solutions.

**Design is our attitude.** And our work is the best way of demonstrating it, making it a hallmark that is engraved on each of our projects.



CUSTOMISED  
INDIVIDUALISED  
DESIGN SYSTEM,  
ATTENTION PAID TO  
EVERY LAST DETAIL.

DESIGN  
ATTITUDE

# CUSTOM FURNITURE



We work with the aim of developing new design concepts in which space and distribution are the differential value. The main advantage of any type of bespoke furniture is its total adaptability, as they are unique pieces which fit perfectly into the space, giving it personality and making it unique.



### STORAGE

The best-selling bespoke furniture aims to optimise the bathroom storage capacity, a need that a ready-made piece of furniture does not satisfy.



### FINISHES

The possibility of choosing the raw material, the colours... is another advantage of bespoke furniture. The pieces are fully available in all types of materials and finishes.



### DELIVERY TIMES

We have to bear in mind that the manufacture of any bespoke furniture requires time, so it is always advisable to plan ahead for this type of orders.



### ENVIRONMENT

KYRYA® is committed to complying with all current and future laws related to environmental protection and to the search for recyclable materials.

**BESPOKE AND FULLY CUSTOM DESIGN SYSTEM THAT TAKES CARE OF EVEN THE TINIEST DETAILS**

**MORE THAN 500,000 COMBINATIONS**

We work to order

## A UNIQUE WAY OF MANUFACTURING EXCEPTIONAL FURNITURE

We manufacture our furniture piece by piece.

Each order leads to a piece of furniture with specific measurements and finishes that the customer has chosen from more than half a million possible combinations.

A process that seamlessly combines **technology and craftsmanship**.



DISCOVER THE ADVANTAGES OF BEING PART OF



### TECHNICAL DATA SHEETS

Access all our product data sheets and assembly instructions quickly and easily.



1

Open the QR code that you will find at the start of each chapter throughout this catalogue.

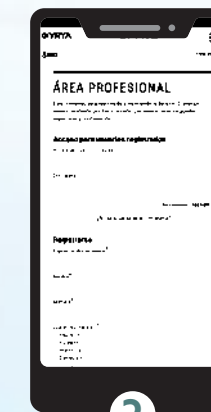

2

If you are new, register in our PROFESSIONAL AREA, if you are already a user, log in with your password.

Remember your access data to log in automatically.

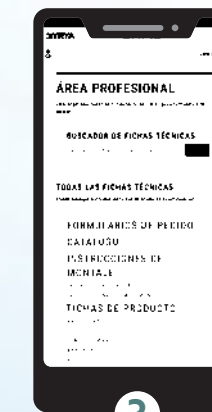

3

Access our product finder and get direct access to all the necessary technical information.

An order, a product and a specific manufacturing process to give it its final shape.

# STEPS TO CUSTOM DESIGN YOUR FURNITURE

①

## CHOOSE THE FURNITURE



Select the layout and size (width, height and depth) of your bathroom furniture from the designs offered by KYRYA®.

②

## CHOOSE THE STRUCTURE



KYRYA® offers 6 different options for furniture structures. Grouped into: Classic, Bars and Cuadro.

③

## CHOOSE THE OPENING AND FRONTS



KYRYA® offers a handle and handleless range to customise the opening systems, with 25 different designs and finishes.

④

## CHOOSE THE FINISHES



Customise the exterior of your KYRYA® furniture, choosing from five series of finishes: Fantasy, Arlux, Fenix, Wood and Lacquer.

⑤

## CHOOSE THE WASHBASINS



KYRYA® offers a wide range of countertops with **built-in basins** and **countertop basins** in Durian®, Pivstone® and Porcelain.

⑥

## CHOOSE THE MIRRORS AND LIGHTING



KYRYA® sets trends in the bathroom with a wide variety of backlit and decorative mirrors in different shapes, as well as pendant and wall lightings.



# DRAWERS

KYRYA® offers the possibility of choosing between the GRASS® XP drawers with no extra cost and SCALA drawers at an extra cost +£37,15/unit.

Both models have **STONE** finish on the metal sides and **SKIN SOUL** on the base.

-  SOFT CLOSE
-  GUARANTEED OPENING
-  VERY RESISTANT
-  VARIETY OF MEASUREMENTS



## RUNNER SIZE ACCORDING TO WASTE TYPE

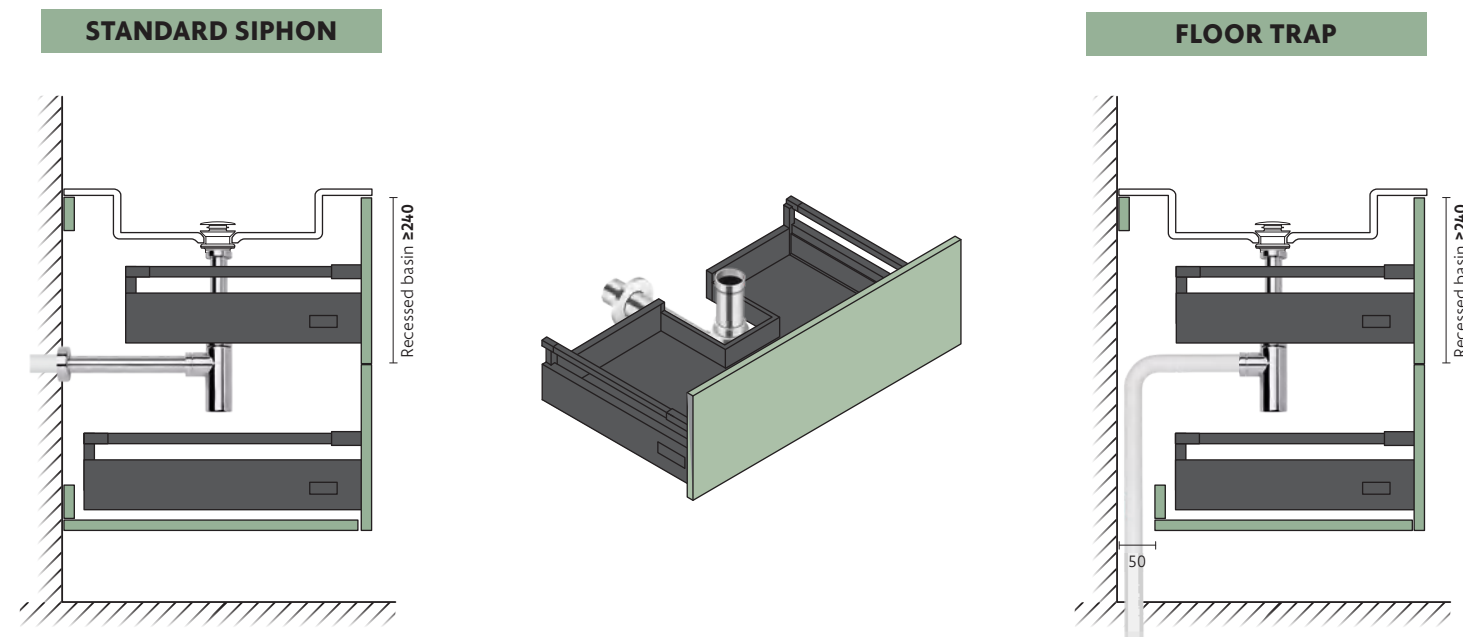



### STORE EVERYTHING YOU WANT

**TOP DRAWER**  
KYRYA® gives you the option to customise the top drawer by choosing different siphon options to increase its capacity.

**BOTTOM DRAWER**  
KYRYA® offers you as standard the largest storage capacity on the market by increasing the depth by 5 cm (except in floor trap).

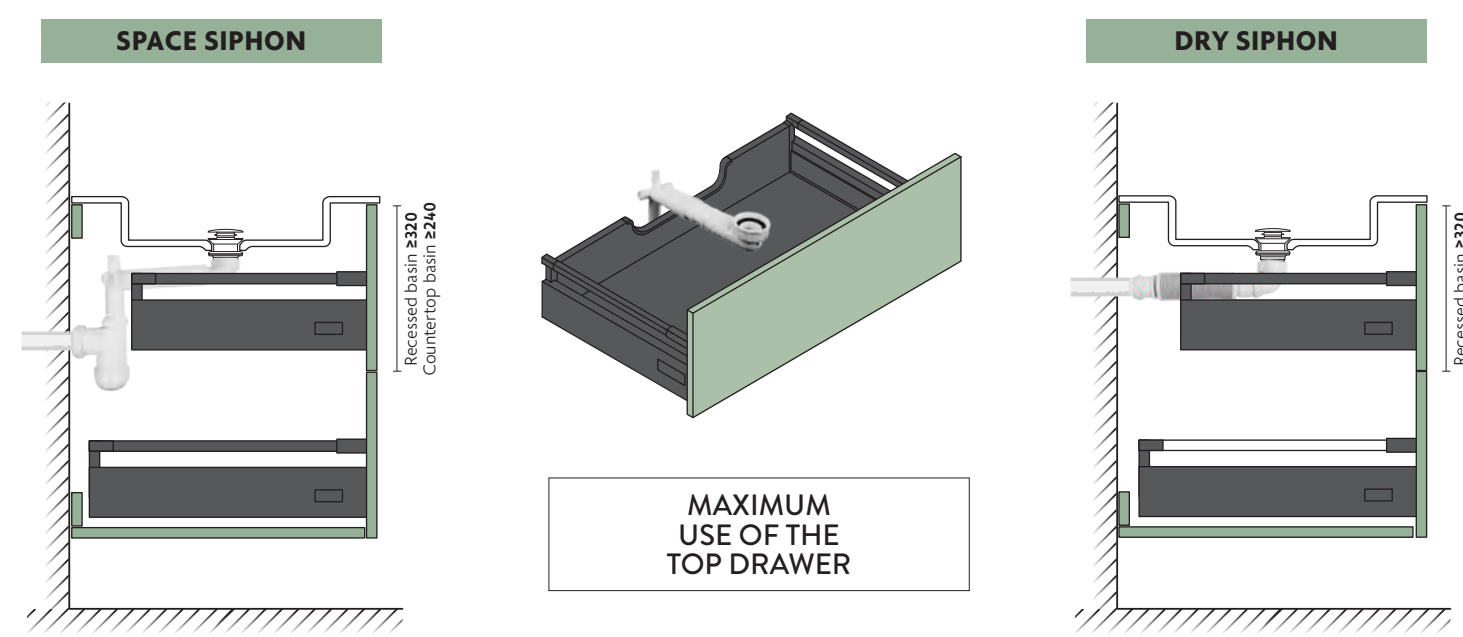

MAXIMUM USE OF THE TOP DRAWER

## RUNNER SIZE ACCORDING TO DEPTH OF UNIT

### FOR WASHBASIN UNITS

DRAWER	DEPTH 50	DEPTH 45	DEPTH 40	DEPTH 35
XP TOP	runner 40	runner 35	runner 30	runner 27
XP BOTTOM	runner 45	runner 40	runner 35	runner 30
SCALA TOP	runner 40	runner 35	runner 27	runner 27
SCALA BOTTOM	runner 45	runner 40	runner 35	runner 27

### FOR VANITY UNITS

DRAWER	DEPTH 50	DEPTH 45	DEPTH 40	DEPTH 35
XP TOP	runner 45	runner 40	runner 35	runner 30
XP BOTTOM	runner 45	runner 40	runner 35	runner 30
SCALA TOP	runner 45	runner 40	runner 35	runner 27
SCALA BOTTOM	runner 45	runner 40	runner 35	runner 27

- See maximum and minimum measurements on the technical data sheet.
- SCALA Push minimum drawer width 30 cm.
- The runners on units with floor trap have the same depth.





### YOU'RE FREE FOREVER

We feel free when we create and we work in search of sublime results. We like to anticipate our customers' needs and we know that the first step to reach their expectations is to be clear about them.

**Quality is not casual**, but the result of observation, work and attention to detail.

# CONTENTS

- 01.** STRUCTURES / OPENING SYSTEMS
- 02.** WASHBASIN UNITS
- 03.** VANITY UNITS MODULAR
- 04.** SHELVES / COUNTERTOPS / BENCHES
- 05.** COMPLEMENTS / GLASS FRONTS / STRUCTURES
- 06.** WALL UNITS / COLUMNS
- 07.** MIRRORS / CABINETS / LIGHTING
- 08.** COUNTERTOPS / WASHBASINS
- 09.** FINISHES

# 01.

## STRUCTURES & OPENING SYSTEMS

### structures

structures with no extra cost



CLASSIC



BARS 2



CUADRO 2 OPEN

premium structures



BARS 1



CUADRO 1 OPEN



BARS 3 CURVED

### opening systems

handleless



METAL MITRE



METAL OLA



ANSO



GOLA



GOLA LED

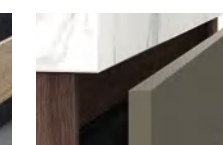

STRAIGHT

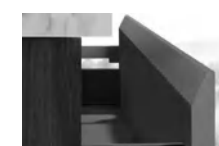

MITRE

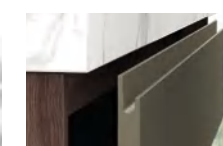

OLA

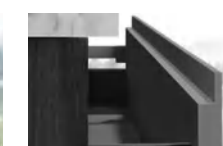

ELE

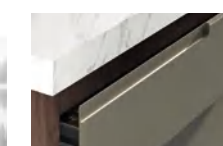

LARA



TWO-TONE HADA



PUSH

handles



ANNA



NEW STANDARD

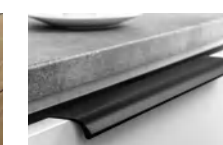

GINA



DIANA



CRISTINA



CRISTINA WOOD

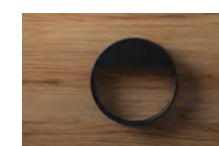

BEA



BRUNA



FANNY



PAOLA

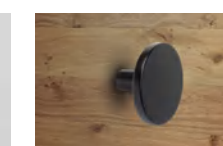

CARMEN

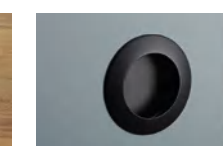

HELEN



More information and assembly instructions.

# STRUCTURES

NO EXTRA COST

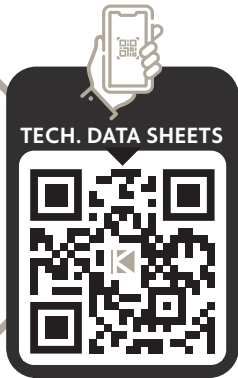

**Classic**, traditional structure where the front closes on the frame. It allows us to create modular developments to adapt to all spaces.

**Bars 2**, structure that wraps around the sides of the fronts, creating a solution to avoid side obstacles.

**Cuadro 2 open**, structure that creates a perimeter around the fronts, framing the units.

The choice of structure finish does not condition the drawer or door fronts finish.

## bars 2

NO EXTRA COST

COMPACT

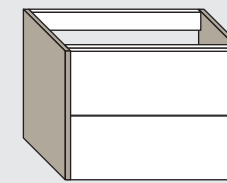

MODULAR

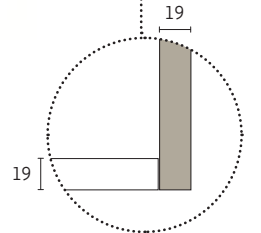
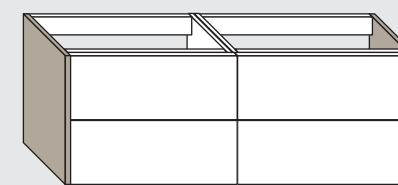

• 2 cm thick sides.

FANTASY	ARLUX	FENIX	LACQUER	WOOD
✓	✓	✓	✓	✓

## classic

NO EXTRA COST

COMPACT

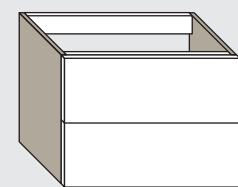

MODULAR

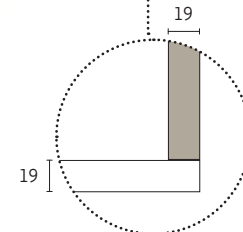
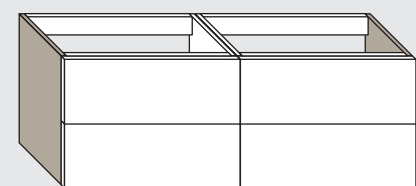

• Unless otherwise stated, the furniture will be manufactured in Classic structure with the strips in the same finish.

FANTASY	ARLUX	FENIX	LACQUER	WOOD
✓	✓	✓	✓	✓

## cuadro 2 open

NO EXTRA COST

COMPACT

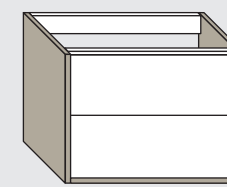

MODULAR

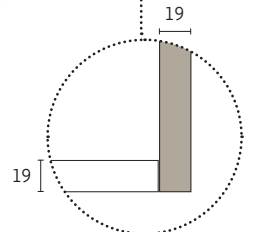
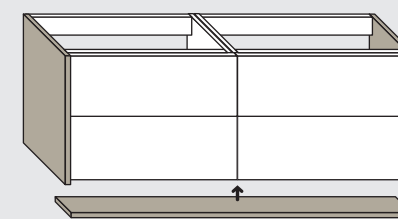

• 2 cm thick perimeter.

FANTASY	ARLUX	FENIX	LACQUER	WOOD
✓	✓	✓	✓	✓





# STRUCTURES

## PREMIUM

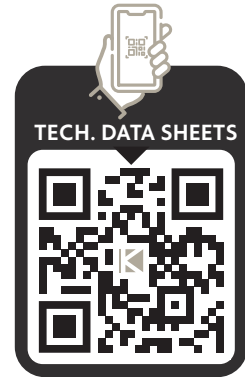

**Bars 1 and Bars 3 curved,** structure that wraps around the sides of the fronts, creating a solution to avoid side obstacles.

**Cuadro 1 open,** structure that creates a perimeter around the fronts, framing the units.

The premium structures are available in lacquer and wood, and can be combined with fronts in any of the finishes KYRYA® offers.

The choice of structure finish does not condition the drawer or door fronts finish.

### cuadro 1 open PREMIUM

COMPACT

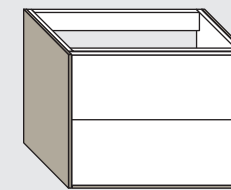

MODULAR

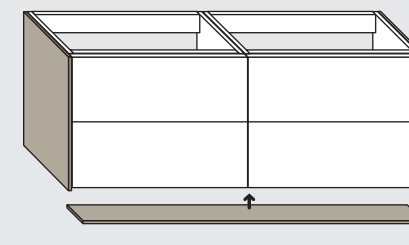

• 1 cm thick perimeter.

	FANTASY	ARLUX	FENIX	LACQUER	WOOD
FRONT	▲	▲	▲	✓	✓
STRUCTURE	+278,64				

▲ 1.2 cm laminated sides and base, always in Wood or Lacquer.

### bars 1 PREMIUM

COMPACT

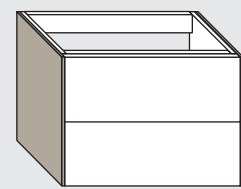

MODULAR

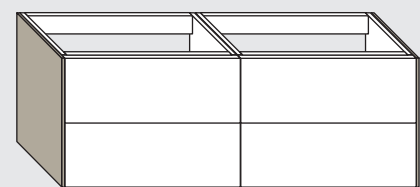

	FANTASY	ARLUX	FENIX	LACQUER	WOOD
FRONT	▲	▲	▲	✓	✓
STRUCTURE	+185,76				

▲ 1.2 cm laminated sides, always in Wood or Lacquer.

### bars 3 curved PREMIUM

COMPACT

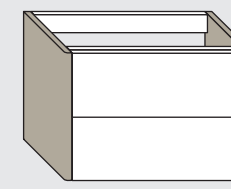

MODULAR

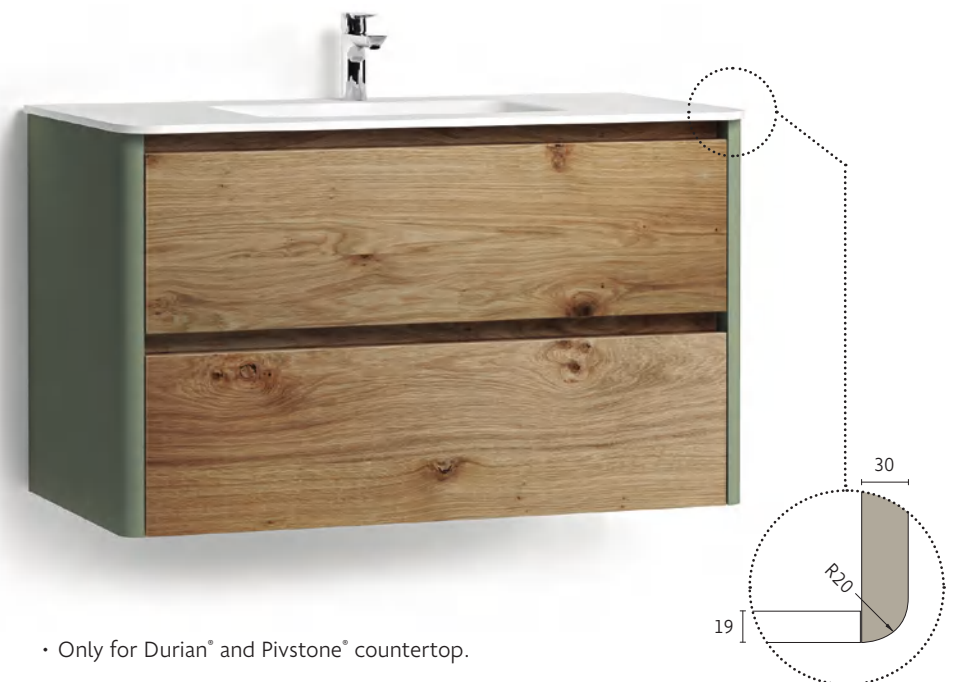
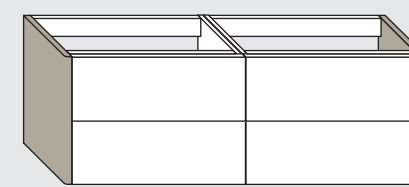

• Only for Durian® and Pivstone® countertop.

	FANTASY	ARLUX	FENIX	LACQUER	WOOD
FRONT	▲	▲	▲	✓	▲
STRUCTURE	+222,91				

▲ 3 cm sides, always in Lacquer



# OPENING SYSTEMS

## HANDLELESS & HANDLES

The visible strips have a height of 3 cm and this is considered the front measurement.

Possibility of choosing between any handleless or handles with no extra cost, except Push, Straight and Gola Led.

Unless otherwise stated, the handles will be supplied in **Position 1 (P1)** except Straight Handleless and Gola in **Position 2 (P2)** for depths ≤47 cm.

The handle measurements indicated in this price list refer to the exterior dimension.

Change of position or size of handles +€46,44/unit, (see technical table).

Handles on drawers are centred and on doors they are positioned off-centre.



### metal mitre

#### WITH STRIP

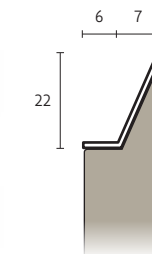
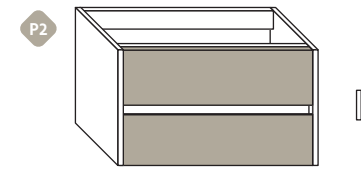
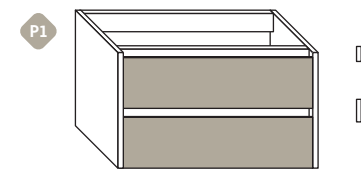

FANTASY	ARLUX	FENIX	LACQUER	WOOD
✓	✓	✓	✓	✓



More information and assembly instructions.

metal ola

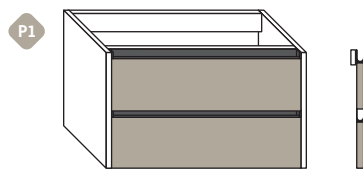

The handleless recess measures the same as the width of the front.

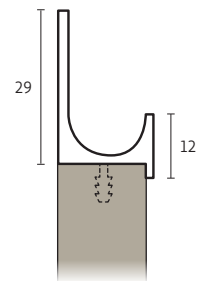

FANTASY	ARLUX	FENIX	LACQUER	WOOD
✓	✓	✓	✓	✓



gola

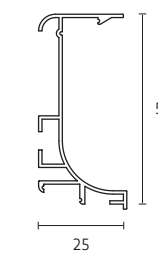
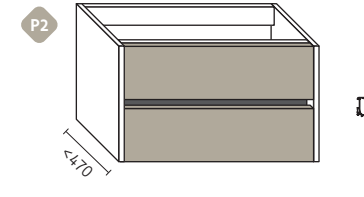
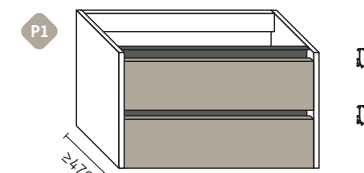

FANTASY	ARLUX	FENIX	LACQUER	WOOD
✓	✓	✓	✓	✓

Gola can be supplied continuous without LED up to 200 cm.

anso

WITH STRIP

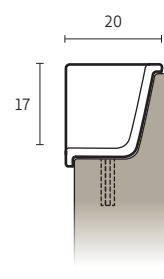
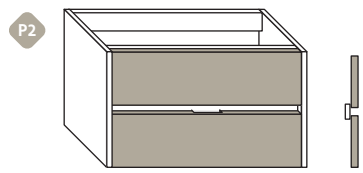
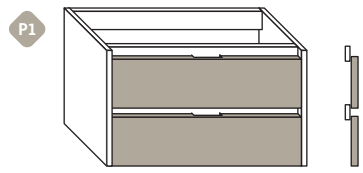

FANTASY	ARLUX	FENIX	LACQUER	WOOD
✓	✓	✓	✓	✓

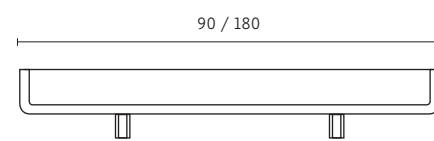

gola led

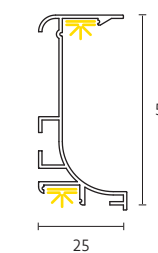
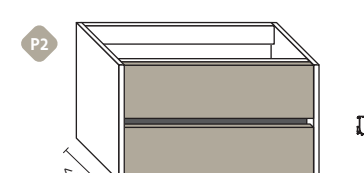
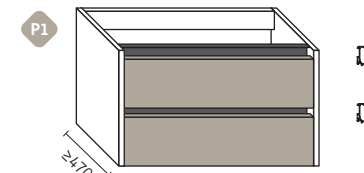

FANTASY	ARLUX	FENIX	LACQUER	WOOD
+334,37				

- Led activated by opening and closing sensor.
- Light temperature 4000°K.
- Not valid for compact units, see technical data sheet.



straight

WITH STRIP

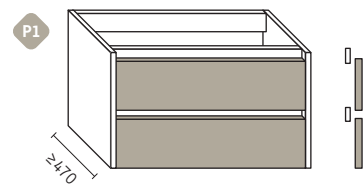

Position 1

For furniture depth of 47 cm or more, except countertop washbasin.

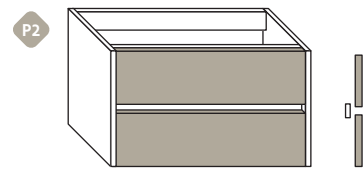

FANTASY	ARLUX	FENIX	LACQUER	WOOD
✓	✓	✓	✓	✓

ola

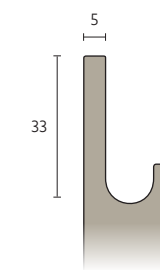
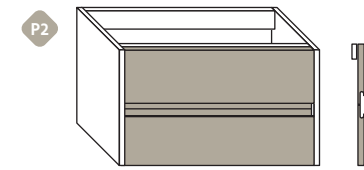
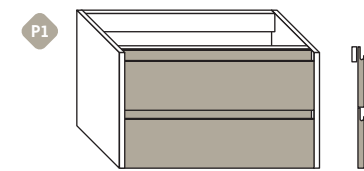

FANTASY	ARLUX	FENIX	LACQUER	WOOD
✗	✗	✗	✓	✗

mitre

WITH STRIP

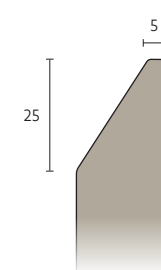
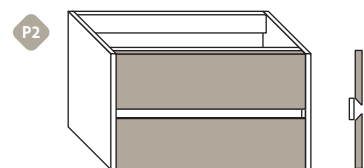
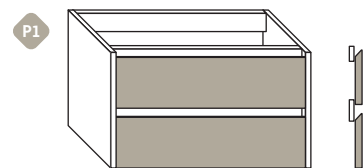

FANTASY	ARLUX	FENIX	LACQUER	WOOD
✗	✗	✗	✓	✓

ele

WITH STRIP

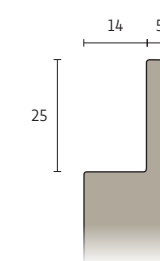
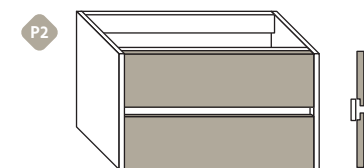
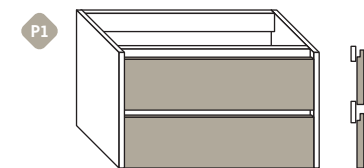

FANTASY	ARLUX	FENIX	LACQUER	WOOD
✗	✗	✗	✓	✗



lara

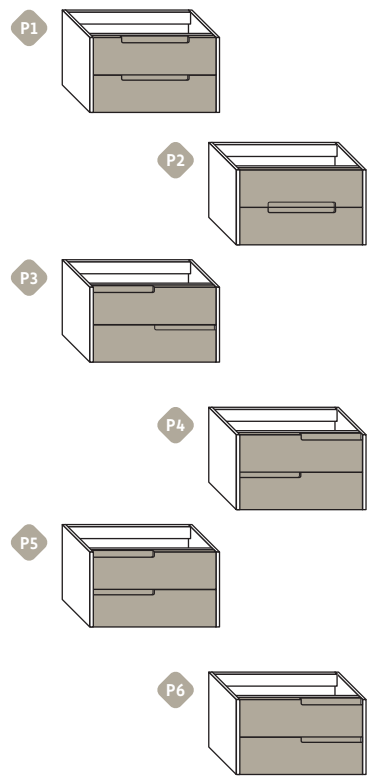

The handleless recess measures half the width of the front. Unless otherwise stated, it is supplied in **P1**.

FANTASY	ARLUX	FENIX	LACQUER	WOOD
X	X	X	✓	X

two-tone hada

WITH STRIP

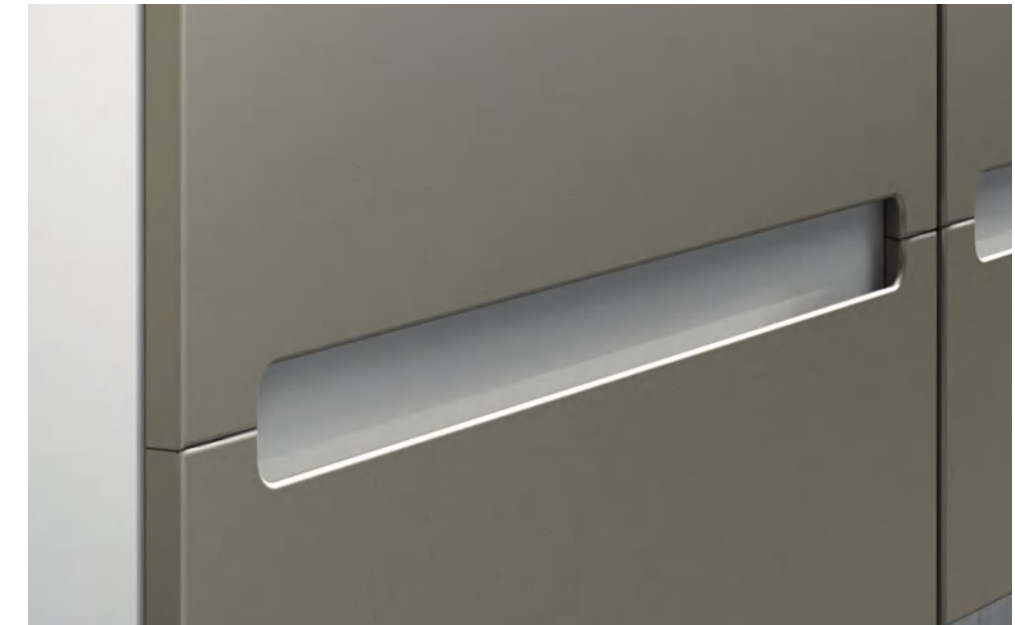
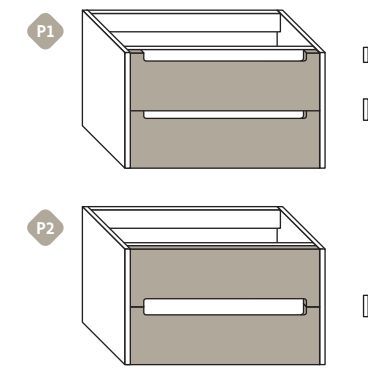

The handleless recess is 5 cm less on each side than the front.

FANTASY	ARLUX	FENIX	LACQUER	WOOD
X	X	X	✓	X



push

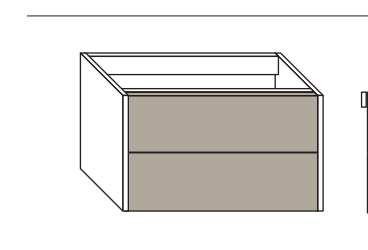

Exclusive opening system for SCALA drawer with stabiliser bar. Minimum drawer width 30 cm.

	FANTASY	ARLUX	FENIX	LACQUER	WOOD
DRAWER	+102,17/drawer				
DOOR	+37,15/door				



anna

/20 - 40 - 60 cm./



BLACK

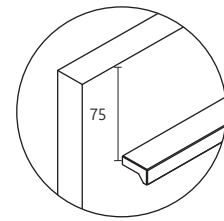

FANTASY	ARLUX	FENIX	LACQUER	WOOD
✓	✓	✓	✓	✓

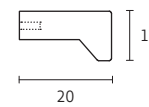
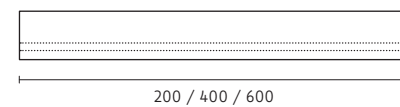

gina

/20 - 35 - 60 cm./

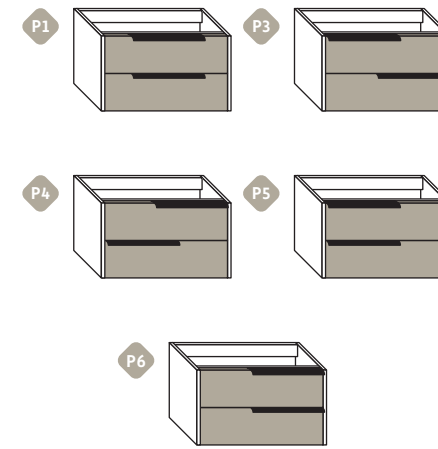

BLACK



WHITE



GOLD

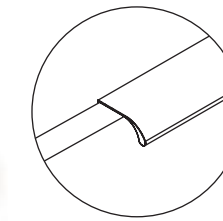
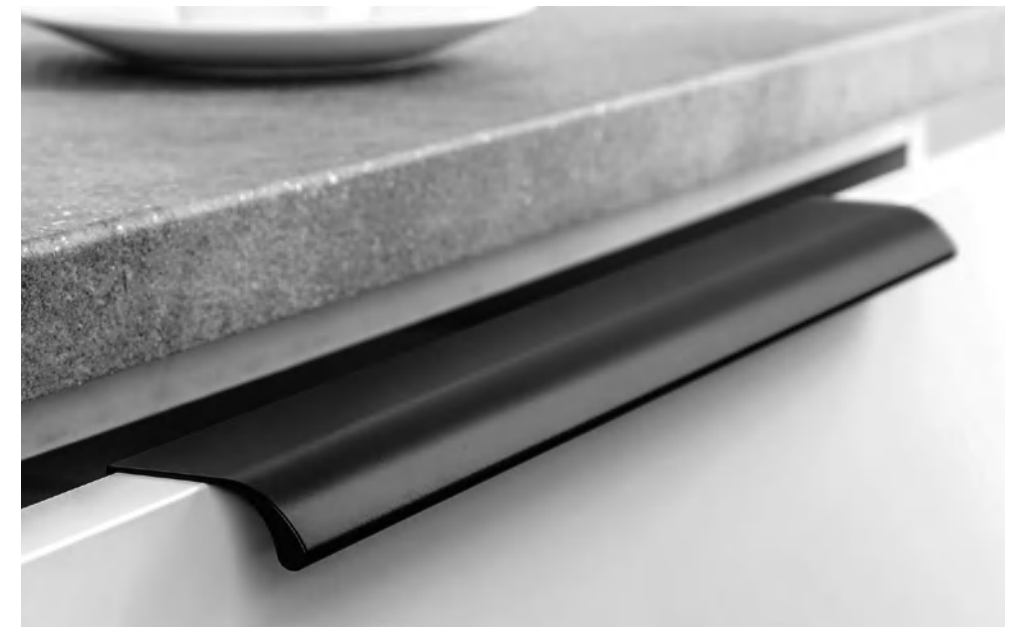

FANTASY	ARLUX	FENIX	LACQUER	WOOD
✓	✓	✓	✓	✓

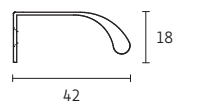
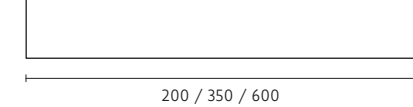

new standard

/14 - 20 - 32 - 50 cm./



BLACK



WHITE



CHROME



GOLD

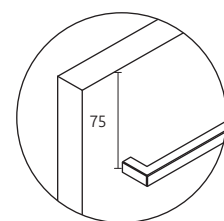

FANTASY	ARLUX	FENIX	LACQUER	WOOD
✓	✓	✓	✓	✓

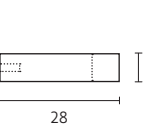
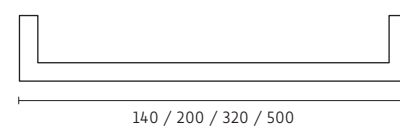

diana

/14 - 20 - 32 - 50 cm./



BLACK



CHROME

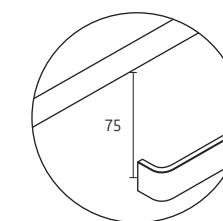

FANTASY	ARLUX	FENIX	LACQUER	WOOD
✓	✓	✓	✓	✓

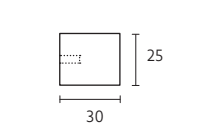
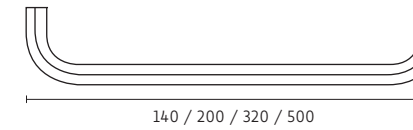

cristina LSM

/20 - 40 - 60 cm./

SELECT MATT LACQUER (SML)

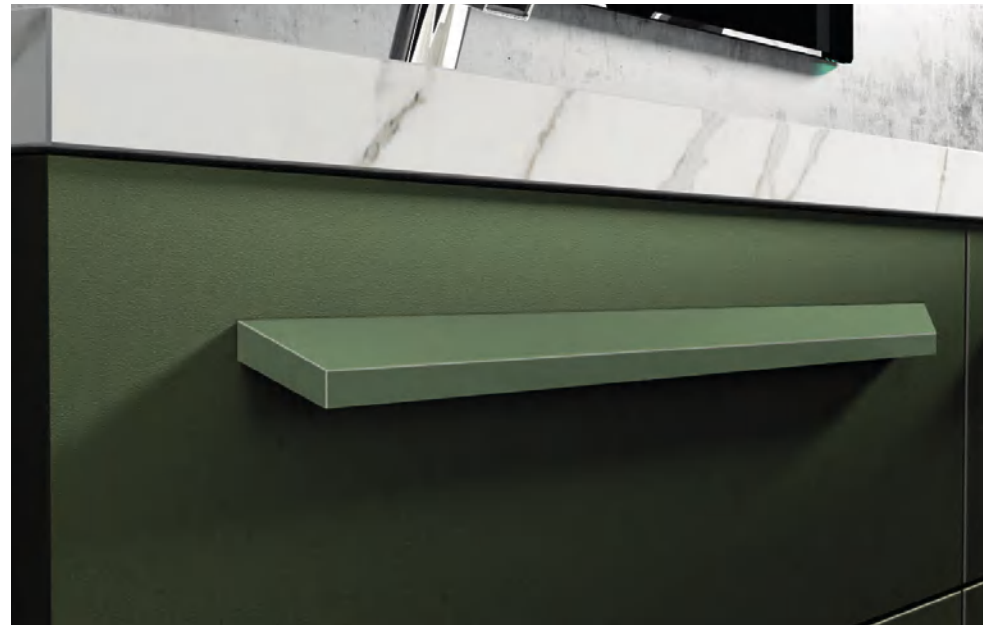

FANTASY	ARLUX	FENIX	LACQUER	WOOD
+83,59/unit	+83,59/unit	+83,59/unit	+83,59/unit	+83,59/unit

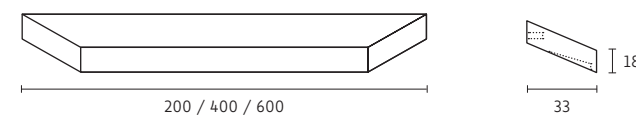

bea

/Ø9 cm./



BLACK

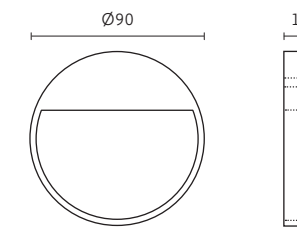

FANTASY	ARLUX	FENIX	LACQUER	WOOD
✓	✓	✓	✓	✓

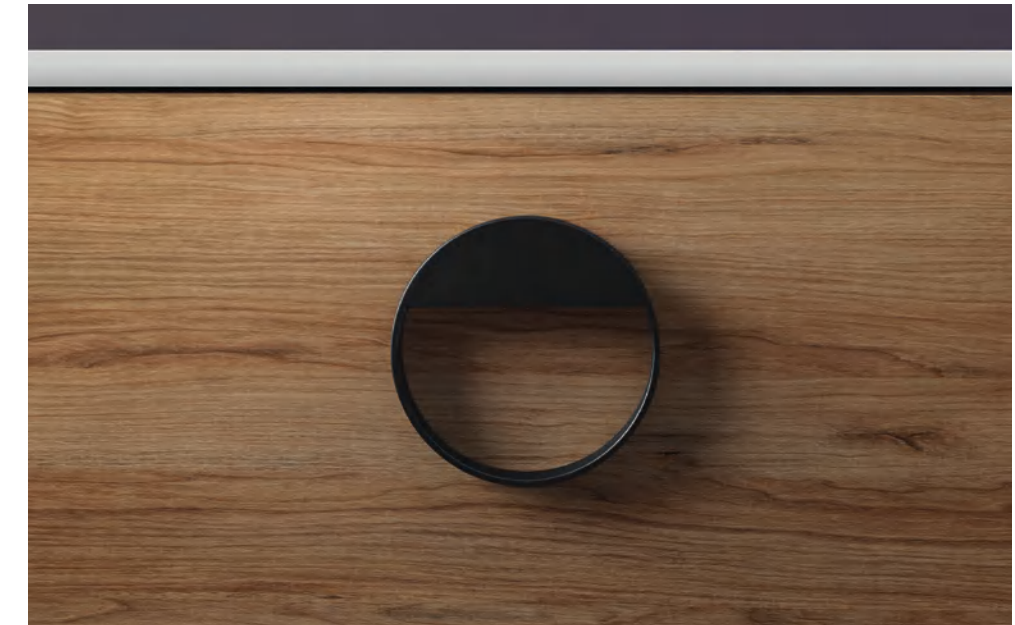

cristina wood

+50,75

/20 - 40 - 60 cm./

WOOD

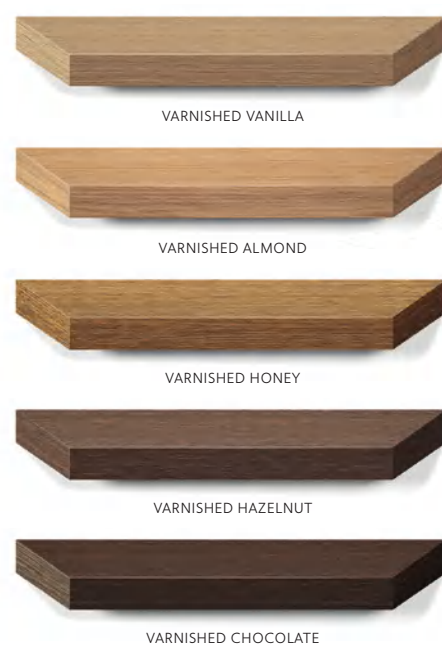

FANTASY	ARLUX	FENIX	LACQUER	WOOD
+65,02/unit	+65,02/unit	+65,02/unit	+65,02/unit	+65,02/unit

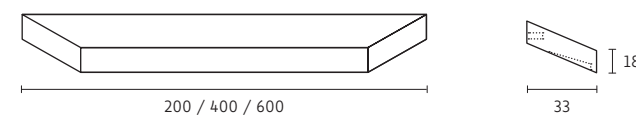

bruna

/Ø4,5 cm./



BLACK/BEECH



BLACK/WHITE

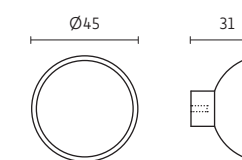

FANTASY	ARLUX	FENIX	LACQUER	WOOD
✓	✓	✓	✓	✓



fanny

/12,6 - 19 - 35 cm./



BLACK

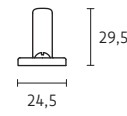
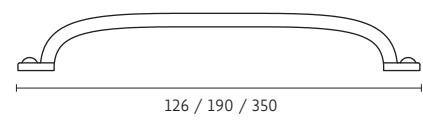

FANTASY	ARLUX	FENIX	LACQUER	WOOD
✓	✓	✓	✓	✓

carmen

/Ø4,1 cm./



BLACK



CHROME

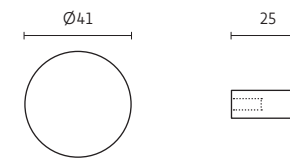

FANTASY	ARLUX	FENIX	LACQUER	WOOD
✓	✓	✓	✓	✓

paola

/9,7 cm./



BLACK



AGED SILVER

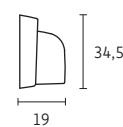
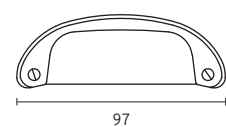

FANTASY	ARLUX	FENIX	LACQUER	WOOD
✓	✓	✓	✓	✓

helen

/Ø6 cm./

SLIDING DOOR



BLACK



CHROME

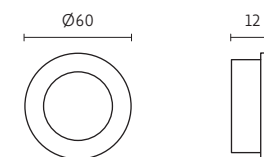

FANTASY	ARLUX	FENIX	LACQUER	WOOD
✓	✓	✓	✓	✓





# 02.

**50**  
DEPTH  
up to 50 cm  
NO EXTRA COST

**RAL LACQUER**  
MATT/GLOSS +15%  
METALLIC +20%

## WASHBASIN UNIT

- Change of proposed distribution in width +£102,17
- Measurements outside the price list 10% increase for every 10 cm. See available ranges on technical data sheet (QR).
- Change of handle size or position +£46,44/module.
- Height up to 88 cm with 10 cm plinth +15%, see page 51.
- Adaptation for basin by other manufacturer, check availability and price.
- Second siphon machining (cut-out) +£65,02.
- Minimum drawer height for basins 24 cm.
- Minimum drawer height for basins to plan 32 cm.
- Option compact drawers on opposite side with no increase.
- Drawers height under 30 cm supplied without tensioners.
- Information on drawer runners see page 06.
- Internal plug installed in drawer 3 cm from the side.
- 3-position rack not available with Push opening.

  
**BOTTOM LED**  
+£232,20

  
**INTERIOR PLUG**  
+£126,32

  
**INTERIOR DRAWER**  
+£204,34

  
**3-POSITION RACK**  
+£37,15

  
**BUILT-IN SPEAKER**  
+£427,25

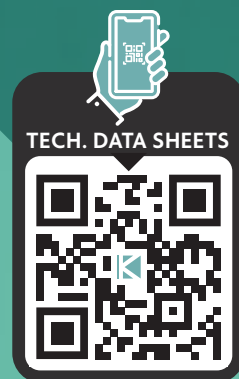

### 1 drawer (32)

  
+£232,20

  
+£126,32

  
+£427,25

Ref.:	Width up to	Depth up to	Height up to	FANTASY	ARLUX	SELECT LAC. MATT FENIX	WOOD
L26	60	50	32	469,97	574,00	650,16	704,03
	70	50	32	508,98	614,87	704,03	763,47
	80	50	32	553,56	655,73	757,90	821,06
	90	50	32	579,57	694,74	809,91	876,79
	100	50	32	603,72	718,89	861,93	932,52
	120	50	32	646,44	769,05	904,65	978,96



### 1 drawer (48)

  
+£232,20

  
+£126,32

  
+£204,34

  
+£427,25

Ref.:	Width up to	Depth up to	Height up to	FANTASY	ARLUX	SELECT LAC. MATT FENIX	WOOD
L06	60	50	48	518,27	637,16	761,62	822,92
	70	50	48	557,28	685,45	813,63	908,37
	80	50	48	588,86	737,47	867,50	921,37
	90	50	48	618,58	769,05	932,52	1.042,11
	100	50	48	642,73	793,20	991,96	1.051,40
	120	50	48	692,88	891,65	1.079,27	1.144,28



### 1 drawer / 1 decorative unit (32+24)

  
+£126,32

  
+£427,25

Ref.:	Width up to	Depth up to	Height up to	FANTASY	ARLUX	SELECT LAC. MATT FENIX	WOOD
L33	60	50	56	635,30	780,19	1.003,10	1.172,15
	70	50	56	665,02	819,20	1.079,27	1.261,31
	80	50	56	696,60	873,07	1.149,85	1.346,76
	90	50	56	724,46	917,65	1.231,59	1.439,64
	100	50	56	754,19	945,52	1.309,61	1.530,66
	120	50	56	778,33	1.027,25	1.465,65	1.710,85

• Available in Classic and Cuadro 2 structures.



### 1 drawer / 2 decorative units

  
+£126,32

  
+£204,34

  
+£427,25

Ref.:	Width up to	Depth up to	Height up to	FANTASY	ARLUX	SELECT LAC. MATT FENIX	WOOD
L40	100	50	48	759,76	1.023,54	1.580,82	1.708,99
	120	50	48	852,64	1.116,42	1.729,43	1.800,01

• Only for displaced basins.

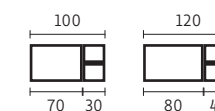

More information and assembly instructions.

1 DRAWER + 1 DRAWER VERSIONS

-  +£232,20
-  +£126,32
-  +£204,34
-  +£427,25

1+1 asymmetrical drawer  
DISPLACED / CENTRED BASIN

Ref.:	Width up to	Depth up to	Height up to	FANTASY	ARLUX	SELECT LAC. MATT FENIX	WOOD
L24	100	50	48	917,65	1.056,97	1.207,44	1.294,75
	120	50	48	952,95	1.151,71	1.281,74	1.370,91

\* Width less than 100 cm only with displaced basin.

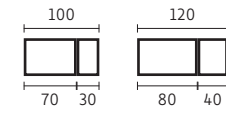

-  +£232,20
-  +£126,32
-  +£204,34
-  +£427,25

1+1 asymmetrical drawer  
CENTRED BASIN

Ref.:	Width up to	Depth up to	Height up to	FANTASY	ARLUX	SELECT LAC. MATT FENIX	WOOD
L25	80	50	48	912,08	952,95	1.196,29	1.287,32
	90	50	48	952,95	1.038,40	1.265,03	1.352,33
	100	50	48	982,67	1.105,27	1.322,61	1.422,92
	120	50	48	1.030,97	1.201,87	1.406,20	1.508,37

\* Siphon hole size 13 cm.



-  +£232,20
-  +£126,32
-  +£204,34
-  +£427,25

1+1 asymmetrical drawer  
DISPLACED BASIN

Ref.:	Width up to	Depth up to	Height up to	FANTASY	ARLUX	SELECT LAC. MATT FENIX	WOOD
L42	100	50	48	917,65	1.023,54	1.207,44	1.294,75
	120	50	48	952,95	1.114,56	1.281,74	1.370,91





-  +£232,20
-  +£126,32
-  +£204,34
-  +£427,25

1+1 drawer  
DOUBLE BASIN

Ref.:	Width up to	Depth up to	Height up to	FANTASY	ARLUX	SELECT LAC. MATT FENIX	WOOD
L43	100	50	48	954,81	1.069,98	1.255,74	1.333,76
	120	50	48	1.004,96	1.161,00	1.324,47	1.422,92
	140	50	48	1.166,57	1.346,76	1.536,24	1.651,41



2-DRAWER VERSION

-  +£232,20
-  +£126,32
-  +£427,25

2 drawers (24 + 24)

Ref.:	Width up to	Depth up to	Height up to	FANTASY	ARLUX	SELECT LAC. MATT FENIX	WOOD
L44	60	50	48	724,46	845,21	956,66	1.030,97
	70	50	48	757,90	886,08	1.006,82	1.090,41
	80	50	48	782,05	926,94	1.040,26	1.127,56
	90	50	48	835,92	980,81	1.121,99	1.216,73
	100	50	48	904,65	1.075,55	1.161,00	1.276,17
120	50	48	951,09	1.118,28	1.261,31	1.382,05	



-  +£232,20
-  +£126,32
-  +£427,25

2 drawers (24 + 32)

Ref.:	Width up to	Depth up to	Height up to	FANTASY	ARLUX	SELECT LAC. MATT FENIX	WOOD
L07	60	50	56	748,61	880,50	997,53	1.079,27
	70	50	56	780,19	925,08	1.049,54	1.134,99
	80	50	56	809,91	965,95	1.082,98	1.172,15
	90	50	56	861,93	1.023,54	1.168,43	1.263,17
	100	50	56	932,52	1.121,99	1.214,87	1.328,18
	120	50	56	982,67	1.164,72	1.318,90	1.441,50



-  +£232,20
-  +£126,32
-  +£427,25

2 drawers (24 + 40)

Ref.:	Width up to	Depth up to	Height up to	FANTASY	ARLUX	SELECT LAC. MATT FENIX	WOOD
L08	60	50	64	778,33	904,65	997,53	1.112,70
	70	50	64	811,77	958,52	1.081,12	1.201,87
	80	50	64	839,64	1.014,25	1.134,99	1.259,45
	90	50	64	895,36	1.064,40	1.194,44	1.324,47
	100	50	64	973,38	1.172,15	1.281,74	1.422,92
	120	50	64	1.023,54	1.192,58	1.385,77	1.536,24



-  +£232,20
-  +£126,32
-  +£427,25

2 drawers (32 + 32)

Ref.:	Width up to	Depth up to	Height up to	FANTASY	ARLUX	SELECT LAC. MATT FENIX	WOOD
L09	60	50	64	776,48	947,38	1.056,97	1.151,71
	70	50	64	813,63	995,67	1.116,42	1.237,16
	80	50	64	863,78	1.038,40	1.175,86	1.305,89
	90	50	64	902,79	1.097,84	1.252,02	1.393,20
	100	50	64	969,67	1.136,85	1.324,47	1.473,08
	120	50	64	1.008,68	1.214,87	1.417,35	1.567,81







4-DRAWER VERSIONS

4 asymmetrical drawers  
DISPLACED / CENTRED BASIN

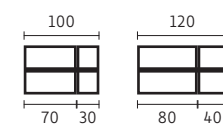
Ref.:	Width up to	Depth up to	Height up to	FANTASY	ARLUX	SELECT LAC. MATT FENIX	WOOD
L12	100	50	64	1.291,03	1.504,66	1.623,54	1.764,72
	120	50	64	1.331,90	1.575,24	1.729,43	1.853,88

• Width less than 100 cm only with displaced basin.





-  +€232,20
-  +€126,32
-  +€427,25

2 drawers / 2 decorative units

Ref.:	Width up to	Depth up to	Height up to	FANTASY	ARLUX	SELECT LAC. MATT FENIX	WOOD
L41	90	50	64	977,10	1.244,59	1.625,40	1.850,17
	100	50	64	1.045,83	1.289,17	1.759,15	1.967,20
	120	50	64	1.172,15	1.406,20	1.909,61	2.121,38

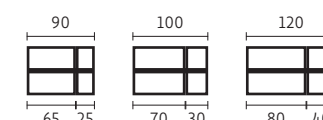
• Only for displaced basins.



-  +€126,32
-  +€427,25

4 symmetrical drawers  
CENTRED BASIN

Ref.:	Width up to	Depth up to	Height up to	FANTASY	ARLUX	SELECT LAC. MATT FENIX	WOOD
L32	80	50	64	1.356,05	1.543,67	1.629,12	1.766,58
	90	50	64	1.395,06	1.575,24	1.723,85	1.844,60
	100	50	64	1.432,21	1.630,97	1.822,31	1.950,48
	120	50	64	1.476,79	1.688,56	1.943,05	2.061,94

• Siphon hole size 13 cm.







-  +€232,20
-  +€126,32
-  +€427,25

2 drawers / 1 top decorative unit

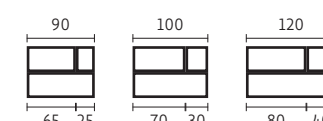
Ref.:	Width up to	Depth up to	Height up to	FANTASY	ARLUX	SELECT LAC. MATT FENIX	WOOD
L36	90	50	64	977,10	1.233,45	1.380,20	1.614,25
	100	50	64	1.021,68	1.289,17	1.473,08	1.723,85
	120	50	64	1.077,41	1.378,34	1.556,67	1.824,16

• Only for displaced basins.





-  +€232,20
-  +€126,32
-  +€427,25

4 symmetrical drawers  
DISPLACED BASIN

Ref.:	Width up to	Depth up to	Height up to	FANTASY	ARLUX	SELECT LAC. MATT FENIX	WOOD
L45	100	50	64	1.291,03	1.504,66	1.623,54	1.798,16
	120	50	64	1.331,90	1.575,24	1.729,43	1.852,03



-  +€232,20
-  +€126,32
-  +€427,25

2 drawers / 1 bottom decorative unit

Ref.:	Width up to	Depth up to	Height up to	FANTASY	ARLUX	SELECT LAC. MATT FENIX	WOOD
L34	80	50	64	912,08	1.148,00	1.463,79	1.664,41
	90	50	64	947,38	1.203,72	1.556,67	1.770,29
	100	50	64	977,10	1.274,31	1.630,97	1.874,32
	120	50	64	1.010,53	1.365,34	1.729,43	1.967,20

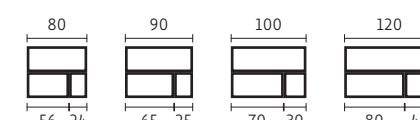



-  +€126,32
-  +€427,25

4 drawers  
DOUBLE BASIN

Ref.:	Width up to	Depth up to	Height up to	FANTASY	ARLUX	SELECT LAC. MATT FENIX	WOOD
L46	100	50	64	1.389,48	1.603,11	1.725,71	1.907,76
	120	50	64	1.430,35	1.675,56	1.829,74	2.024,78
	140	50	64	1.658,84	1.943,05	2.123,24	2.348,01



-  +€232,20
-  +€126,32
-  +€427,25

4 crossed drawers

Ref.:	Width up to	Depth up to	Height up to	FANTASY	ARLUX	SELECT LAC. MATT FENIX	WOOD
L38	100	50	64	1.374,62	1.519,52	1.677,41	1.814,88
	120	50	64	1.422,92	1.655,12	1.800,01	1.946,76

• Width less than 100 cm only with displaced basin.

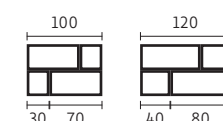

-  +€232,20
-  +€126,32
-  +€427,25



### 2 top drawers / 1 bottom drawer

Ref.:	Width up to	Depth up to	Height up to	FANTASY	ARLUX	SELECT LAC. MATT FENIX	WOOD
L30	100	50	64	1.190,72	1.378,34	1.465,65	1.627,26
	120	50	64	1.226,02	1.439,64	1.623,54	1.710,85

• Width less than 100 cm only with displaced basin.

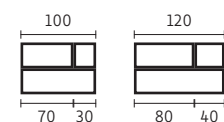

- +€232,20
- +€126,32
- +€427,25

### 3 drawers

Ref.:	Width up to	Depth up to	Height up to	FANTASY	ARLUX	SELECT LAC. MATT FENIX	WOOD
L10	60	50	76	978,96	1.159,14	1.276,17	1.450,79
	70	50	76	1.017,96	1.207,44	1.315,18	1.489,80
	80	50	76	1.090,41	1.253,88	1.382,05	1.547,38
	90	50	76	1.116,42	1.318,90	1.504,66	1.684,84
	100	50	76	1.175,86	1.372,77	1.539,95	1.725,71
120	50	76	1.216,73	1.439,64	1.677,41	1.879,89	



- +€232,20
- +€126,32
- +€427,25

### 1 top drawer / 2 bottom drawers

Ref.:	Width up to	Depth up to	Height up to	FANTASY	ARLUX	SELECT LAC. MATT FENIX	WOOD
L35	80	50	64	1.097,84	1.296,60	1.382,05	1.532,52
	90	50	64	1.155,43	1.328,18	1.454,50	1.616,11
	100	50	64	1.190,72	1.378,34	1.465,65	1.627,26
	120	50	64	1.226,02	1.439,64	1.623,54	1.801,87

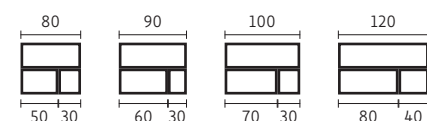

- +€232,20
- +€126,32
- +€427,25

### 1 door

Ref.:	Width up to	Depth up to	Height up to	FANTASY	ARLUX	SELECT LAC. MATT FENIX	WOOD
L27	50	50	64	406,81	512,70	724,46	809,91
	60	50	64	447,68	564,71	796,91	891,65

• Indicate side



- +€37,15

### 1+2 top drawers / 1 bottom drawer DISPLACED BASIN

Ref.:	Width up to	Depth up to	Height up to	FANTASY	ARLUX	SELECT LAC. MATT FENIX	WOOD
L37	90	50	64	1.298,46	1.473,08	1.567,81	1.640,26
	100	50	64	1.333,76	1.525,09	1.630,97	1.710,85
	120	50	64	1.372,77	1.573,39	1.766,58	1.826,02

• Only for displaced basin, top drawer always with cut-out.  
• Cabinet always P1 and small drawers P2.

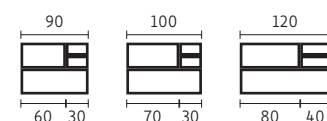

- +€232,20
- +€126,32
- +€427,25

### 2 doors

Ref.:	Width up to	Depth up to	Height up to	FANTASY	ARLUX	SELECT LAC. MATT FENIX	WOOD
L01	50	50	64	458,83	613,01	728,18	808,06
	60	50	64	482,98	655,73	770,90	884,22
	70	50	64	529,42	707,75	811,77	930,66
	80	50	64	555,42	720,75	854,50	958,52



- +€37,15

### 1 drawer / 2 drawers

Ref.:	Width up to	Depth up to	Height up to	FANTASY	ARLUX	SELECT LAC. MATT FENIX	WOOD
L31	100	50	48	1.086,70	1.226,02	1.454,50	1.571,53
	120	50	48	1.185,15	1.317,04	1.584,53	1.714,56

• Width less than 100 cm only with displaced basin.

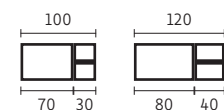

- +€232,20
- +€126,32
- +€204,34
- +€427,25

### 3 doors

Ref.:	Width up to	Depth up to	Height up to	FANTASY	ARLUX	SELECT LAC. MATT FENIX	WOOD
L21	80	50	64	683,60	852,64	995,67	1.086,70
	90	50	64	726,32	895,36	1.034,68	1.108,99
	100	50	64	782,05	928,80	1.071,84	1.149,85
	120	50	64	828,49	986,39	1.168,43	1.255,74



- +€37,15







2 doors / 1 drawer

-  +£232,20
-  +£126,32
-  +£37,15

Ref.:	Width up to	Depth up to	Height up to	FANTASY	ARLUX	SELECT LAC. MATT FENIX	WOOD
L02	60	50	64	713,32	863,78	993,82	1.108,99
	70	50	64	759,76	930,66	1.073,69	1.198,15
	80	50	64	782,05	952,95	1.120,13	1.237,16



3 drawers / 1 door

-  +£232,20
-  +£126,32
-  +£37,15
-  +£427,25

Ref.:	Width up to	Depth up to	Height up to	FANTASY	ARLUX	SELECT LAC. MATT FENIX	WOOD
L22	80	50	76	1.134,99	1.354,19	1.486,08	1.651,41
	90	50	76	1.196,29	1.398,77	1.591,96	1.768,44
	100	50	76	1.224,16	1.448,93	1.673,70	1.859,46
	120	50	76	1.333,76	1.552,95	1.801,87	2.000,64

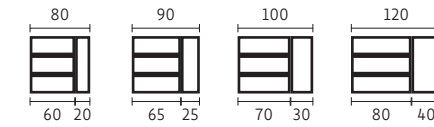

Option P2 with Push door.

2 doors / 2 drawers

-  +£232,20
-  +£126,32
-  +£37,15
-  +£427,25

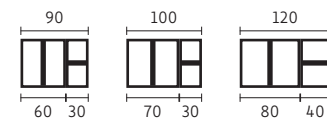

Ref.:	Width up to	Depth up to	Height up to	FANTASY	ARLUX	SELECT LAC. MATT FENIX	WOOD
L11	90	50	64	978,96	1.179,58	1.309,61	1.454,50
	100	50	64	1.014,25	1.226,02	1.369,05	1.517,66
	120	50	64	1.077,41	1.292,89	1.474,93	1.638,40

• Width less than 100 cm only with displaced basin.



Option P2 with Push door.

1 door / 2 drawers / 1 door

-  +£126,32
-  +£37,15
-  +£427,25

Ref.:	Width up to	Depth up to	Height up to	FANTASY	ARLUX	SELECT LAC. MATT FENIX	WOOD
L18	100	50	64	1.107,13	1.309,61	1.411,78	1.567,81
	120	50	64	1.201,87	1.437,78	1.590,11	1.766,58

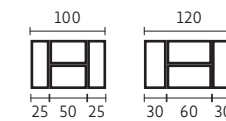

Option P2 with Push door.

2 doors / 3 drawers

-  +£232,20
-  +£126,32
-  +£37,15
-  +£427,25

Ref.:	Width up to	Depth up to	Height up to	FANTASY	ARLUX	SELECT LAC. MATT FENIX	WOOD
L17	90	50	76	1.140,57	1.378,34	1.512,09	1.735,00
	100	50	76	1.177,72	1.422,92	1.578,96	1.811,16
	120	50	76	1.226,02	1.504,66	1.705,28	1.956,05

• Width less than 100 cm only with displaced basin.

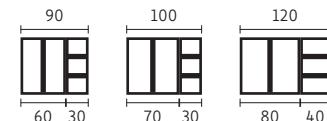

Option P2 with Push door.

2 sliding doors

-  +£37,15

Ref.:	Width up to	Depth up to	Height up to	FANTASY	ARLUX	SELECT LAC. MATT FENIX	WOOD
L39	60	50	64	902,79	1.155,43	1.415,49	1.567,81
	70	50	64	947,38	1.213,01	1.487,94	1.647,69
	80	50	64	995,67	1.276,17	1.556,67	1.727,57

- Always Cuadro structure.
- Only available with Helen handle.
- Not suitable for modular.



2 drawers / 1 door

-  +£232,20
-  +£126,32
-  +£37,15
-  +£427,25

Ref.:	Width up to	Depth up to	Height up to	FANTASY	ARLUX	SELECT LAC. MATT FENIX	WOOD
L13	80	50	64	938,09	1.116,42	1.246,45	1.385,77
	90	50	64	978,96	1.159,14	1.313,32	1.460,07
	100	50	64	1.012,39	1.201,87	1.365,34	1.515,80
	120	50	64	1.073,69	1.291,03	1.465,65	1.630,97

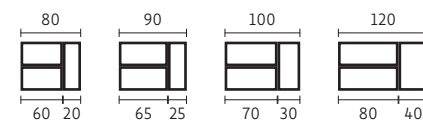

Option P2 with Push door.

corner unit 1 door

Ref.:	Width up to	Depth up to	Height up to	FANTASY	ARLUX	SELECT LAC. MATT FENIX	WOOD
L29	60/60	32s/32s	64	587,00	698,46	811,77	906,51

- Indicate side.
- Not valid with Gola handle.



# 03.

## VANITY UNITS MODULAR

**50**  
DEPTH  
Up to 50 cm  
NO EXTRA COST

**RAL LACQUER**  
MATT/GLOSS +15%  
METALLIC +20%

- Height up to 88 cm with 10 cm plinth +15%, see page 51.
- Minimum drawer height 16 cm (in the case of opening system with strip minimum 19 cm).
- Measurements outside the price list 10% increase for every 10 cm. See available ranges on technical data sheet (QR).
- Change of handle size or position +£46,44 /module. Check availability on technical data sheet.
- The vanity unit fronts are represented in Wood Legno finish, decorative units and side panels in RAL 7015, top finish not included (white).
- The vanity units need a countertop (top is not finished).
- Minimum drawer depth 32.5 cm.
- Interior plug installed in drawer 3 cm from the side.
- 3-position rack not available with Push opening.

**BOTTOM LED**  
+£232,20

**INTERNAL PLUG**  
+£126,32

**INTERNAL DRAWER**  
+£204,34

**3-POSITION RACK**  
+£37,15

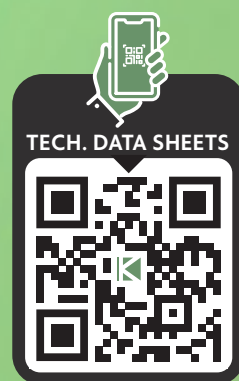

### 1 door



Ref.:	Width up to	Depth up to	Height up to	FANTASY	ARLUX	SELECT LAC. MATT FENIX	WOOD
C01	30	50	64	380,81	414,24	482,98	525,70
	35	50	64	404,96	449,54	514,56	561,00
	40	50	64	419,82	466,26	546,13	598,15
	45	50	64	430,96	488,55	577,71	644,59

• Indicate side.



### 2 doors



Ref.:	Width up to	Depth up to	Height up to	FANTASY	ARLUX	SELECT LAC. MATT FENIX	WOOD
C02	50	50	64	490,41	557,28	600,00	659,45
	60	50	64	508,98	588,86	665,02	733,75
	70	50	64	546,13	620,44	724,46	798,77
	80	50	64	575,86	661,31	782,05	861,93



### 1 drawer / 1 door



Ref.:	Width up to	Depth up to	Height up to	FANTASY	ARLUX	SELECT LAC. MATT FENIX	WOOD
C03	30	50	64	531,27	579,57	627,87	685,45
	35	50	64	561,00	598,15	650,16	704,03
	40	50	64	577,71	620,44	687,31	728,18

• Indicate side.



### 1 drawer



Ref.:	Width up to	Depth up to	Height up to	FANTASY	ARLUX	SELECT LAC. MATT FENIX	WOOD
C10	30	50	32	429,11	466,26	497,84	538,70
	50	50	32	447,68	488,55	525,70	568,43
	70	50	32	492,26	546,13	603,72	666,88
	90	50	32	544,28	603,72	691,03	763,47
	110	50	32	566,57	653,88	767,19	848,92



More information and assembly instructions.

www.kyrya.es

### 1 drawer

-  +€232,20
-  +€126,32
-  +€204,34

Ref.:	Width up to	Depth up to	Height up to	FANTASY	ARLUX	SELECT LAC. MATT FENIX	WOOD
<b>C23</b>	30	50	48	469,97	520,13	547,99	592,57
	50	50	48	508,98	572,14	626,01	691,03
	70	50	48	553,56	616,72	720,75	795,05
	90	50	48	592,57	681,74	828,49	913,94
	110	50	48	613,01	720,75	884,22	975,24





### washing machine cabinet

Ref.:	Width up to	Depth up to	Height up to	FANTASY	ARLUX	SELECT LAC. MATT FENIX	WOOD
<b>C34</b>	70→80	65→70	88	696,60	821,06	1.040,26	1.270,60

- Not valid for opening systems with strip.
- Removable plinth.



### 2 drawers

-  +€232,20
-  +€126,32
-  +€204,34

Ref.:	Width up to	Depth up to	Height up to	FANTASY	ARLUX	SELECT LAC. MATT FENIX	WOOD
<b>C05</b>	30	50	64	661,31	702,17	750,47	804,34
	50	50	64	737,47	800,63	893,51	977,10
	70	50	64	813,63	899,08	1.036,54	1.151,71
	90	50	64	889,79	995,67	1.136,85	1.274,31



### cube

Ref.:	Width up to	Depth up to	Height up to	FANTASY	ARLUX	SELECT LAC. MATT FENIX	WOOD
<b>C28</b>	40→50	35→50	50→64	613,01	678,02	746,76	806,20

- For handleless minimum height 50 cm.



### 3 drawers

-  +€232,20
-  +€126,32

Ref.:	Width up to	Depth up to	Height up to	FANTASY	ARLUX	SELECT LAC. MATT FENIX	WOOD
<b>C06</b>	30	50	76	819,20	908,37	938,09	999,39
	50	50	76	893,51	986,39	1.056,97	1.166,57
	70	50	76	1.003,10	1.107,13	1.240,88	1.369,05
	90	50	76	1.095,98	1.224,16	1.426,64	1.575,24





### metal laundry basket

Ref.:	Width up to	Depth up to	Height up to	FANTASY	ARLUX	SELECT LAC. MATT FENIX	WOOD
<b>C27</b>	35	35→50	60→64	561,00	609,29	689,17	767,19
	45	35→50	60→64	611,15	674,31	748,61	808,06

- Opening systems with strip min. height 64 cm.
- Metal laundry basket measurements 27 x 25 cm and 37 x 25 cm (width x depth).



### 4 drawers

-  +€232,20
-  +€126,32

Ref.:	Width up to	Depth up to	Height up to	FANTASY	ARLUX	SELECT LAC. MATT FENIX	WOOD
<b>C11</b>	30	50	64→76	962,24	1.027,25	1.075,55	1.148,00
	50	50	64→76	1.056,97	1.146,14	1.220,44	1.330,04
	70	50	64→76	1.168,43	1.265,03	1.404,35	1.532,52
	90	50	64→76	1.261,31	1.380,20	1.590,11	1.738,71

- Minimum height without strip 64 cm.
- Minimum height with strip 76 cm.



### drawer laundry basket

Ref.:	Width up to	Depth up to	Height up to	FANTASY	ARLUX	SELECT LAC. MATT FENIX	WOOD
<b>C08</b>	30	50	64	583,29	616,72	659,45	704,03
	50	50	64	613,01	692,88	752,33	806,20

- Option custom cloth bag +€176,47.
- Not suitable for SCALA drawer.



sliding doors



+£37,15

Ref.:	Width up to	Depth up to	Height up to	FANTASY	ARLUX	SELECT LAC. MATT FENIX	WOOD
C09	60	50	64	900,94	1.233,45	1.588,25	1.798,16
	70	50	64	943,66	1.305,89	1.666,27	1.879,89
	80	50	64	978,96	1.369,05	1.753,57	1.980,20

- Always Cuadro 2 structure.
- Only available with Helen handle.
- Not valid for modular.



chamfer 1 door

Ref.:	Width up to	Depth up to	Height up to	FANTASY	ARLUX	SELECT LAC. MATT FENIX	WOOD
C26	30	50	64	440,25	521,99	607,44	698,46
	40	50	64	471,83	607,44	670,59	772,76

- Only valid for Classic structure.
- Important to consult the depth options on technical data sheet.
- If fitted against a wall, a vertical strip must be added.

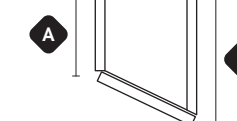

wall-mounted dresser / over unit



DRESSER OVER UNIT C390

Ref.:	Width up to	Depth up to	Height up to	FANTASY	ARLUX	SELECT LAC. MATT FENIX	WOOD
C391	40	40→50	16→24	365,95	468,12	577,71	637,16
	50	40→50	16→24	395,67	494,12	601,86	663,16
	60	40→50	16→24	442,11	553,56	676,17	746,76
	70	40→50	16→24	492,26	614,87	761,62	839,64

- Indicate location; wall-mounted (C391) or over unit (C390).
- Marengo interior.
- The door overhangs 1 cm more than the Classic structure.
- Not valid for modular.



chamfer open decorative unit

Ref.:	Width up to	Depth up to	Height up to	FANTASY	ARLUX	SELECT LAC. MATT FENIX	WOOD
C33	30	50	64	360,37	481,12	737,47	861,93
	40	50	64	432,82	540,56	863,78	1.008,68

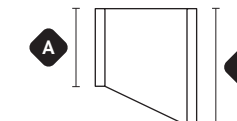

stool

Ref.:	Width	Depth	Height up to	FANTASY	ARLUX	SELECT LAC. MATT FENIX	WOOD
C31	40	40	50	583,29	720,75	908,37	1.060,69

- Marengo interior.
- Height including upholstered seat ±2 cm.
- Seat upholstered in black eco-leather.



1 drawer / decorative unit



+£126,32

Ref.:	Width up to	Depth up to	Height up to	FANTASY	ARLUX	SELECT LAC. MATT FENIX	WOOD
C25	30	50	64	495,98	681,74	783,91	884,22
	40	50	64	531,27	748,61	858,21	967,81
	50	50	64	564,71	817,34	932,52	1.053,26
	60	50	64	600,00	884,22	965,95	1.088,55

- Cube flush with the structure.



towel holder

Ref.:	Width	Depth	Height	FANTASY	ARLUX	SELECT LAC. MATT FENIX	WOOD
C12	21→30	32→50	64	373,38	518,27	676,17	787,62

- Unless otherwise stated, it is supplied flush with the front.
- Towel holder fittings included.
- Second towel holder fitting +£92,88.



decorative unit / 1 drawer



+£232,20



+£126,32

Ref.:	Width up to	Depth up to	Height up to	FANTASY	ARLUX	SELECT LAC. MATT FENIX	WOOD
C24	30	50	64	495,98	681,74	783,91	884,22
	40	50	64	531,27	748,61	858,21	967,81
	50	50	64	564,71	817,34	932,52	1.053,26
	60	50	64	600,00	884,22	965,95	1.088,55

- Cube flush with the structure.





open decorative unit

Ref.:	Width up to	Depth up to	Height up to	FANTASY	ARLUX	SELECT LAC. MATT FENIX	WOOD
C13	40	50	32	256,35	341,80	406,81	488,55
	60	50	32	278,64	408,67	503,41	568,43
	80	50	32	323,22	482,98	566,57	618,58

- Unless otherwise stated, it is supplied flush with the front.
- Minimum height 18 cm.



decorative unit / 1 sliding door

Ref.:	Width up to	Depth up to	Height up to	FANTASY	ARLUX	SELECT LAC. MATT FENIX	WOOD
C32	60	50	64	653,88	1.027,25	1.265,03	1.476,79
	80	50	64	726,32	1.149,85	1.402,49	1.638,40

- Always Cuadro 2 structure.
- Only available with Helen handle.



double open decorative unit

Ref.:	Width up to	Depth up to	Height up to	FANTASY	ARLUX	SELECT LAC. MATT FENIX	WOOD
C14	40	50	64	306,50	419,82	544,28	616,72
	60	50	64	345,51	486,69	607,44	679,88

- Unless otherwise stated, it is supplied flush with the front.



bathtub open decorative unit

Ref.:	Width up to	Depth up to	Height up to	Cubes	FANTASY	ARLUX	SELECT LAC. MATT FENIX	WOOD
C41	100	25	58.8	4	508,98	904,65	1.322,61	1.647,69
	200	25	58.8	6	672,45	1.073,69	1.623,54	1.850,17
	220	25	58.8	6	806,20	1.287,32	1.948,62	2.221,69

- Supplied with modular plinth.



side open decorative unit

Ref.:	Width up to	Depth up to	Height up to	FANTASY	ARLUX	SELECT LAC. MATT FENIX	WOOD
C29	15	50	64	269,35	395,67	538,70	629,73
	25	50	64	295,36	468,12	655,73	765,33

- Supplied without hooks.



4 sides deco interior laminated

Ref.:	Width up to	Depth up to	Height up to	FANTASY	ARLUX	SELECT LAC. MATT FENIX	WOOD
C131	40	50	32	159,75	241,49	274,92	310,22
	60	50	32	198,76	287,93	326,94	375,24
	80	50	32	230,34	341,80	377,09	436,54

- 12 mm thickness for Lacquer and Wood.
- 19 mm thickness for Fantasia, Arlux and Fenix.
- Supplied mounted on the inside of its decorative unit.



open decorative unit 4 cubes

Ref.:	Width up to	Depth up to	Height up to	FANTASY	ARLUX	SELECT LAC. MATT FENIX	WOOD
C40	40	50	64	352,94	486,69	665,02	735,61
	60	50	64	408,67	540,56	726,32	819,20
	80	50	64	458,83	705,89	834,06	1.004,96

- Unless otherwise stated, it is supplied flush with the front.



5 sides deco interior laminated

Ref.:	Width up to	Depth up to	Height up to	FANTASY	ARLUX	SELECT LAC. MATT FENIX	WOOD
C132	40	50	32	182,04	276,78	382,67	442,11
	60	50	32	221,05	330,65	464,40	538,70
	80	50	32	260,06	390,10	533,13	616,72

- 12 mm thickness for Lacquer and Wood.
- 19 mm thickness for Fantasia, Arlux and Fenix.
- Supplied mounted on the inside of its decorative unit.



### HIGH VANITY UNITS (HALF COLUMNS)

#### 1 door

Ref.:	Width up to	Depth up to	Height up to	FANTASY	ARLUX	SELECT LAC. MATT FENIX	WOOD
M56	30	35	85	460,68	644,59	782,05	912,08
	40	35	85	497,84	698,46	865,64	1.012,39
M17	30	50	115	534,99	793,20	980,81	1.148,00
	40	50	115	579,57	865,64	1.090,41	1.272,46

- Indicate side.
- Cover included.

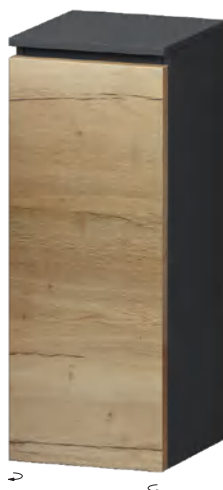

#### 4 drawers

Ref.:	Width up to	Depth up to	Height up to	FANTASY	ARLUX	SELECT LAC. MATT FENIX	WOOD
M66	30	33→35	85	1.131,28	1.317,04	1.406,20	1.588,25
	40	33→35	85	1.181,43	1.389,48	1.504,66	1.703,42
M67	30	35→50	115	1.200,01	1.456,36	1.597,54	1.809,30
	40	35→50	115	1.257,60	1.538,09	1.716,42	1.950,48

- Cover included.



#### 2 drawers / 1 door

Ref.:	Width up to	Depth up to	Height up to	FANTASY	ARLUX	SELECT LAC. MATT FENIX	WOOD
M57	30	33→35	85	796,91	982,67	1.071,84	1.253,88
	40	33→35	85	847,07	1.055,12	1.170,29	1.369,05
M19	30	35→50	115	865,64	1.121,99	1.263,17	1.474,93
	40	35→50	115	923,23	1.203,72	1.382,05	1.616,11

- Indicate side
- Cover included.



#### 5 drawers

Ref.:	Width up to	Depth up to	Height up to	FANTASY	ARLUX	SELECT LAC. MATT FENIX	WOOD
M62	30	33→35	97	1.298,46	1.484,22	1.573,39	1.755,43
	40	33→35	97	1.348,62	1.556,67	1.671,84	1.870,60
M63	30	35→50	115	1.367,19	1.623,54	1.764,72	1.976,49
	40	35→50	115	1.424,78	1.705,28	1.883,61	2.117,66

- Cover included.



#### dresser / 1 drawer / 1 door

Ref.:	Width up to	Depth up to	Height up to	FANTASY	ARLUX	SELECT LAC. MATT FENIX	WOOD
M58	40	35	85	956,66	1.179,58	1.285,46	1.504,66
	50	35	85	1.016,11	1.266,88	1.404,35	1.642,12

- Indicate side
- Minimum width 35 cm.
- Interior mirror Ø25 cm.



#### 1 drawer / laundry basket

Ref.:	Width up to	Depth up to	Height up to	FANTASY	ARLUX	SELECT LAC. MATT FENIX	WOOD
M64	30	33→35	85	824,77	861,93	910,22	958,52
	40	33→35	85	858,21	945,52	1.012,39	1.069,98
M65	30	35→50	100	990,10	1.034,68	1.092,27	1.149,85
	40	35→50	100	1.029,11	1.134,99	1.214,87	1.283,60

- Cover included.
- Not available with Scala drawer.
- Optional custom cloth bag +€176,47.



FINISHES

base frame

Ref.:	Width up to	Depth up to	Height min.	FANTASY	ARLUX	SELECT LAC. MATT FENIX	WOOD
F27	60	50	8	180,19	202,48	241,49	280,50
	80	50	8	219,20	243,35	273,07	321,36
	100	50	8	234,06	267,49	325,08	378,95
	120	50	8	243,35	293,50	354,80	416,10

• Unless otherwise stated, width -2 cm and depth -6 cm.



side strip vertical grain

Ref.:	Height up to	Width	FANTASY	ARLUX	SELECT LAC. MATT FENIX	WOOD
F36	76	2→12	46,44	61,30	98,45	102,17
	140	2→12	76,16	98,45	167,18	170,90
	201	2→12	109,60	139,32	219,20	234,06

• Supplied with 3 finished edges (2 short and 1 long).  
• 4 finished edges +€83,59 (minimum width 8 cm).



visible top at extra cost

Ref.:	Width up to	Depth up to	FANTASY	ARLUX	SELECT LAC. MATT FENIX	WOOD
S15	32	50	20,43	29,72	53,87	61,30
	64	50	26,01	39,01	104,03	124,46
	90	50	31,58	65,02	146,75	176,47

• Always between sides.



side strip horizontal grain

Ref.:	Height up to	Width	FANTASY	ARLUX	SELECT LAC. MATT FENIX	WOOD
F16	76	2→12	66,87	83,59	98,45	126,32
	120	2→12	92,88	117,03	167,18	198,76

• Supplied with 3 finished edges (2 short and 1 long).  
• 4 finished edges +€83,59 (minimum width 8 cm).



compact plinth

Width up to	Height	FANTASY	ARLUX	SELECT LAC. MATT FENIX	WOOD
120	8→15	+15%	+15%	+15%	+15%

• Unit sides to the floor.  
• Supplied installed.  
• +15% extra per module.  
• Unless otherwise stated, plinth height 10 cm.



separate finished side 2 cm

Ref.:	Height up to	Depth up to	FANTASY	ARLUX	SELECT LAC. MATT FENIX	WOOD
F30	32	50	79,88	118,89	137,46	152,32
	64	50	120,74	163,47	174,61	198,76
	90	50	130,03	183,90	232,20	260,06



modular plinth

Height	FANTASY	ARLUX	SELECT LAC. MATT FENIX	WOOD
8→15	+15%	+15%	+15%	+15%

• +15% extra per module.  
• Unless otherwise stated, plinth height 10 cm.  
• Supplied separate with attachment to the adjustable interior legs.



# O4A

**50**  
  
**DEPTH**  
 Up to 50 cm  
 NO EXTRA COST

## SHELVES & COUNTERTOPS

Hole depth for washbasin from other manufacturers +£130,03.  
 (technical data sheet must be attached).

For other sizes, please consult price and availability.

Supports not included in countertops.

Countertops are represented in  
 Andes Oak Fantasy and RAL 7015 finish.

  
**MOISTURE RESISTANT**  
 DO NOT WET



### SHELVES

#### shelf thickness 2 cm

Ref.:	Width up to	Depth	Thick-ness	FANTASY	ARLUX	SELECT LAC. MATT FENIX	WOOD
F12	40	10→20	2	131,89	148,61	169,04	178,33
	60	10→20	2	141,18	167,18	202,48	213,62
	80	10→20	2	169,04	193,19	228,48	241,49
	100	10→20	2	187,62	235,92	254,49	289,79
	120	10→20	2	234,06	252,63	276,78	321,36

• Includes hidden support.



#### shelf thickness 3 cm

Ref.:	Width up to	Depth	Thick-ness	FANTASY	ARLUX	SELECT LAC. MATT FENIX	WOOD
F13	40	10→20	3	-	-	211,77	-
	60	10→20	3	-	-	239,63	-
	80	10→20	3	-	-	286,07	-
	100	10→20	3	-	-	334,37	-
	120	10→20	3	-	-	358,52	-

• Includes hidden support.



#### shelf thickness 5 cm

Ref.:	Width up to	Depth	Thick-ness	FANTASY	ARLUX	SELECT LAC. MATT FENIX	WOOD
F15	40	10→20	5	-	-	263,78	280,50
	60	10→20	5	-	-	286,07	336,23
	80	10→20	5	-	-	338,08	371,52
	100	10→20	5	-	-	388,24	453,25
	120	10→20	5	-	-	423,53	492,26

• Includes hidden support.



#### rail shelf

Ref.:	Width up to	Depth	Height	FANTASY	ARLUX	SELECT LAC. MATT FENIX	WOOD
F17	40	12→20	8	224,77	252,63	287,93	302,79
	60	12→20	8	239,63	286,07	343,66	362,23
	80	12→20	8	287,93	330,65	388,24	412,39
	100	12→20	8	319,51	399,38	434,68	492,26
	120	12→20	8	397,53	430,96	471,83	546,13

• Includes hidden support.



More information and assembly instructions.

COUNTERTOPS

countertop thickness 2 cm

Ref.:	Width up to	Depth up to	Thick-ness	FANTASY	ARLUX	SELECT LAC. MATT FENIX	WOOD
F22	41	51	2	130,03	157,90	193,19	226,63
	61	51	2	139,32	180,19	221,05	252,63
	81	51	2	163,47	211,77	260,06	297,22
	101	51	2	191,33	250,78	304,65	351,09
	121	51	2	228,48	300,93	367,80	421,68
	151	51	2	286,07	377,09	456,97	525,70
	181	51	2	343,66	451,40	547,99	629,73
201	51	2	380,81	501,55	611,15	700,32	



COUNTERTOPS

countertop thickness 2 + top panel 6→15 cm

Ref.:	Width up to	Depth up to	Thick-ness	FANTASY	ARLUX	SELECT LAC. MATT FENIX	WOOD
F24	61	51	8→17	228,48	302,79	432,82	505,27
	81	51	8→17	276,78	365,95	525,70	613,01
	101	51	8→17	326,94	430,96	618,58	720,75
	121	51	8→17	391,95	518,27	743,04	865,64
	151	51	8→17	490,41	646,44	928,80	1.079,27
	181	51	8→17	588,86	774,62	1.112,70	1.294,75
	201	51	8→17	653,88	861,93	1.237,16	1.439,64



• Allow New Hidden Support, see page 66.

countertop thickness 3 cm

Ref.:	Width up to	Depth up to	Thick-ness	FANTASY	ARLUX	SELECT LAC. MATT	WOOD
F23	41	51	3	-	-	248,92	-
	61	51	3	-	-	284,21	-
	81	51	3	-	-	336,23	-
	101	51	3	-	-	393,81	-
	121	51	3	-	-	473,69	-
	151	51	3	-	-	588,86	-
	181	51	3	-	-	707,75	-
201	51	3	-	-	787,62	-	

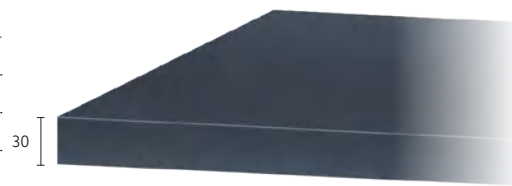

extra for built-in drawer in countertop (left/right)  
FOR COUNTERTOP F24 THICKNESS 2

Ref.:	Width up to	Depth	Height	RRP
S20	40	33→51	15→24	315,79
	60	33→51	15→24	362,23
	80	33→51	15→24	482,98



- Indicate the drawer position (left or right).
- Bottom drawer opening.
- Supports not included.
- Washbasin cannot be placed on top of drawer.
- Minimum countertop width 60 cm.

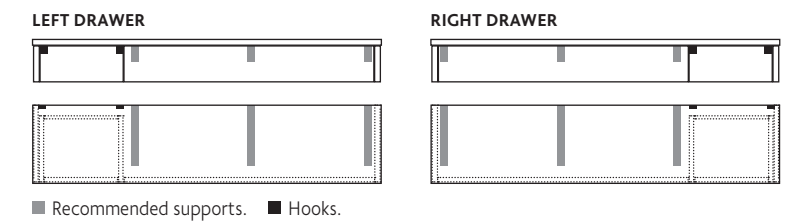

countertop thickness 5 cm

Ref.:	Width up to	Depth up to	Thick-ness	FANTASY	ARLUX	SELECT LAC. MATT	WOOD
F25	61	51	5	-	-	321,36	356,66
	81	51	5	-	-	388,24	445,82
	101	51	5	-	-	514,56	592,57
	121	51	5	-	-	585,14	672,45
	151	51	5	-	-	717,03	824,77
	181	51	5	-	-	867,50	997,53
201	51	5	-	-	1.043,97	1.198,15	

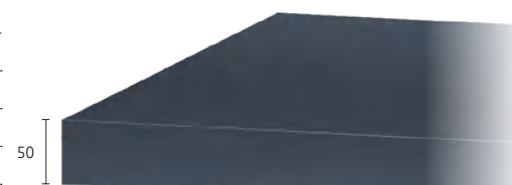

mitred countertop

Ref.:	Width up to	Depth up to	Thick-ness	FANTASY	ARLUX	SELECT LAC. MATT	WOOD
F28	61	51	8→15	-	-	598,15	694,74
	81	51	8→15	-	-	718,89	830,35
	101	51	8→15	-	-	802,48	921,37
	121	51	8→15	-	-	926,94	1.068,12
	151	51	8→15	-	-	1.105,27	1.268,74
	181	51	8→15	-	-	1.268,74	1.460,07
201	51	8→15	-	-	1.391,34	1.599,39	

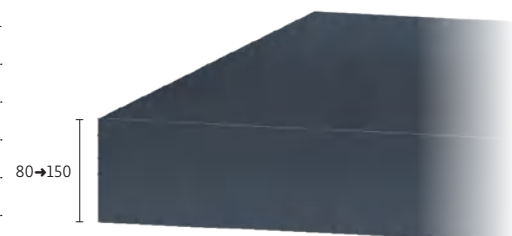

• Allow New Hidden Support, see page 66.



# 04B



**DEPTH**  
Up to 50 cm  
NO EXTRA COST



**RAL LACQUER**  
MATT/GLOSS +15%  
METALLIC +20%

## BENCHES

Countertop included in the price.

Total measurement corresponds to the countertop, supplied with front and side overhang of 0.25 cm.

Minimum bench height 18 cm (21 cm with strip).

Option of countertops with no side overhang, indicate side.

Change of handle size or position +£ 46,44/module.

If not wall mounted, an anti-tip counterweight must be used for widths greater than 40 cm (see prices on page 67):  
Bench 60, counterweight (1x) 50 cm.  
Bench 80, counterweight (2x) 30 cm.  
Bench 100, counterweight (2x) 40 cm.  
Bench 120, counterweight (2x) 50 cm.

Interior plug installed in drawer 3 cm from the side.



**BOTTOM LED**  
+£232,20



**INTERIOR PLUG**  
+£126,32

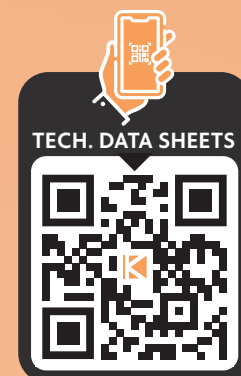

### bench 1 drawer

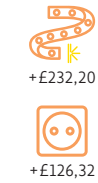

Ref.	Width up to	Depth up to	Height up to	FANTASY	ARLUX	SELECT LAC. MATT FENIX	WOOD
B07	60	50	34	553,56	676,17	809,91	945,52
	80	50	34	614,87	741,18	889,79	1.095,98
	100	50	34	665,02	822,92	1.023,54	1.255,74
	120	50	34	720,75	904,65	1.157,28	1.432,21



### bench 2 drawers

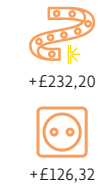

Ref.	Width up to	Depth up to	Height up to	FANTASY	ARLUX	SELECT LAC. MATT FENIX	WOOD
B20	60	50	34	737,47	856,35	951,09	1.053,26
	80	50	34	795,05	936,23	1.077,41	1.194,44
	100	50	34	837,78	1.016,11	1.205,58	1.333,76
	120	50	34	960,38	1.101,56	1.344,90	1.491,65



### bench 3 drawers

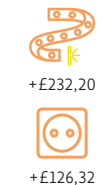

Ref.	Width up to	Depth up to	Height up to	FANTASY	ARLUX	SELECT LAC. MATT FENIX	WOOD
B21	90	50	34	995,67	1.133,14	1.239,02	1.370,91
	100	50	34	1.045,83	1.213,01	1.380,20	1.526,95
	120	50	34	1.088,55	1.292,89	1.499,08	1.660,69
	140	50	34	1.140,57	1.372,77	1.625,40	1.801,87



### bench 1 drawer / 2 drawers

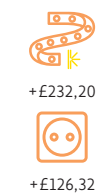

Ref.	Width up to	Depth up to	Height up to	FANTASY	ARLUX	SELECT LAC. MATT FENIX	WOOD
B23	80	50	40→48	1.010,53	1.255,74	1.434,07	1.588,25
	100	50	40→48	1.125,71	1.396,92	1.593,82	1.766,58
	120	50	40→48	1.348,62	1.647,69	1.913,33	2.060,08

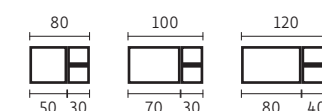

More information and assembly instructions.

# MODULAR BENCHES



The modular benches can be used with Classic and Bar structures.  
 They are made up of vanity units and countertops supplied in individual packs.  
 The modulations allow us to create large benches up to 2.2 m. long.  
 If they are floor-standing, a base must be used (2<sup>nd</sup> countertop) and legs or wheels must be added every 75 cm with the corresponding counterweight.

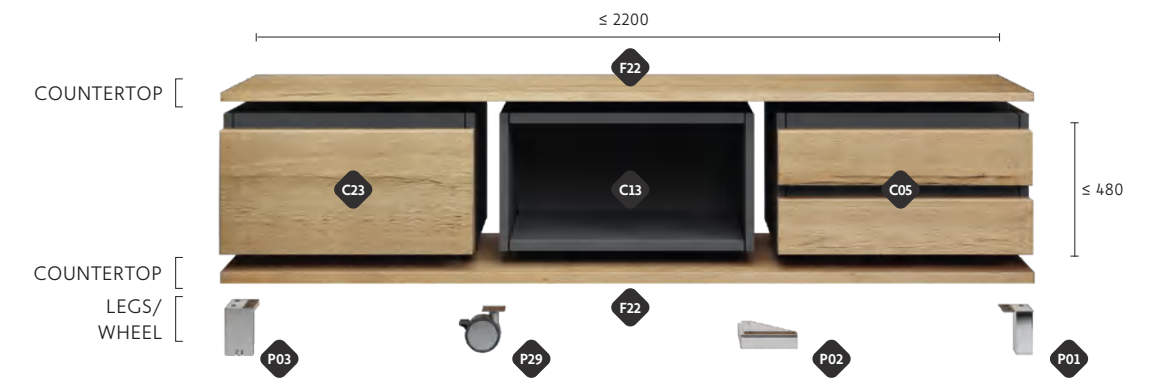

## EXAMPLES OF MODULAR BENCHES:



**2 DRAWERS**  
 C10 + C10 + F22



**1 DRAWER / DECORATIVE UNIT**  
 C10 + C13 + F22



**1 DRAWER / DOUBLE DECORATIVE UNIT**  
 C23 + C14 + F22



**1 DRAWER / DECORATIVE UNIT / 1 DRAWER**  
 C10 + C13 + C10 + F22



**1 DRAWER / 2 DRAWERS**  
 C23 + C05 + F22



**1 DRAWER / 1 DRAWER**  
 C10 + C10 + F22 + F22 + P29 + COUNTERWEIGHT



**1 DRAWER / 2 DRAWERS**  
 C23 + C05 + F22 + P02 (x2) + F22 + COUNTERWEIGHT



**1 DRAWER / DECORATIVE UNIT**  
 C10 + C13 + F22 + F22 + P10 (x3) + COUNTERWEIGHT



# 05.

## COMPLEMENTS, GLASS FRONTS & STRUCTURES



### SIPHONS

#### siphon space

Ref.:	Finish	RRP
P360NC	Chrome cover	139,32
P360ND	Durian <sup>®</sup> cover	250,78

- Includes click-clack waste.
- Valid for all Durian<sup>®</sup> washbasins except for Milano, Florencia 60/80/100 which require a minimum top panel of 5 cm.
- The unit's drawer must be at least 32 cm high.
- Valid for all countertop washbasins (drawer height over 24 cm).

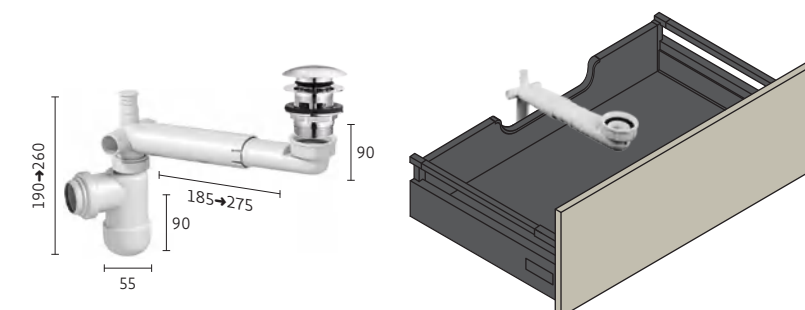

#### standard siphon

Ref.:	Finish	RRP
P370NC	Chrome	102,17
P370NN	Black	120,74

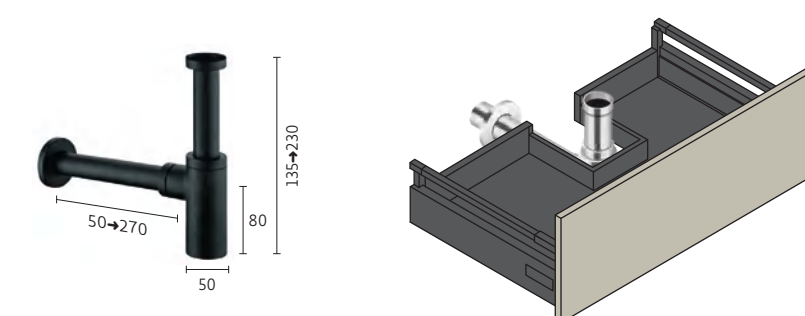

#### dry siphon

Ref.:	Finish	RRP
P380NC	Chrome cover	139,32
P380ND	Durian <sup>®</sup> cover	250,78

- Includes click-clack waste.
- Valid for all Durian<sup>®</sup> washbasins except for Milano, Sicilia 60, Florencia 60/80/100 which require a minimum top panel of 5 cm.
- The unit's drawer must be at least 32 cm high.
- Valid for all countertop washbasins (drawer height over 24 cm).

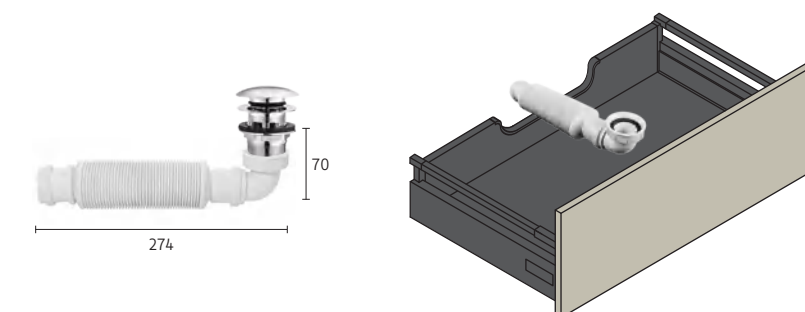

#### click-clack waste

Ref.:	Finish	RRP
P31	Chrome	65,02
P59	Black	65,02
901100000024	Durian <sup>®</sup>	176,47



More information and assembly instructions.



**DRAWER COMPLEMENTS**



**wood organisers**

Ref.:	Article	RRP
F440NN040	Drawer 40 kit (S+S+L)	111,46
F440NN035	Drawer 35 kit (S+S+M)	102,17

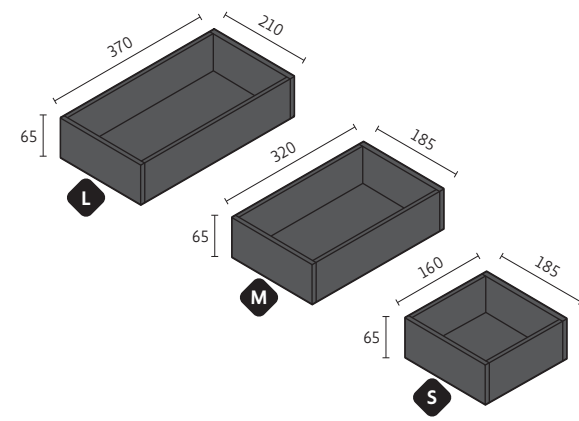

**metal organisers**

Ref.:	Article	Measurement	RRP
P520NN029	Tray (1)	29 x 7.7	102,17
P530NN029	Cosmetics (2)	29 x 15.5	102,17
P520NN013	Tray (3)	13 x 15.5	92,88
P510NN013	Lipstick (4)	13 x 15.5	102,17
P540NN150	Bin (5)	15 x 21	183,90

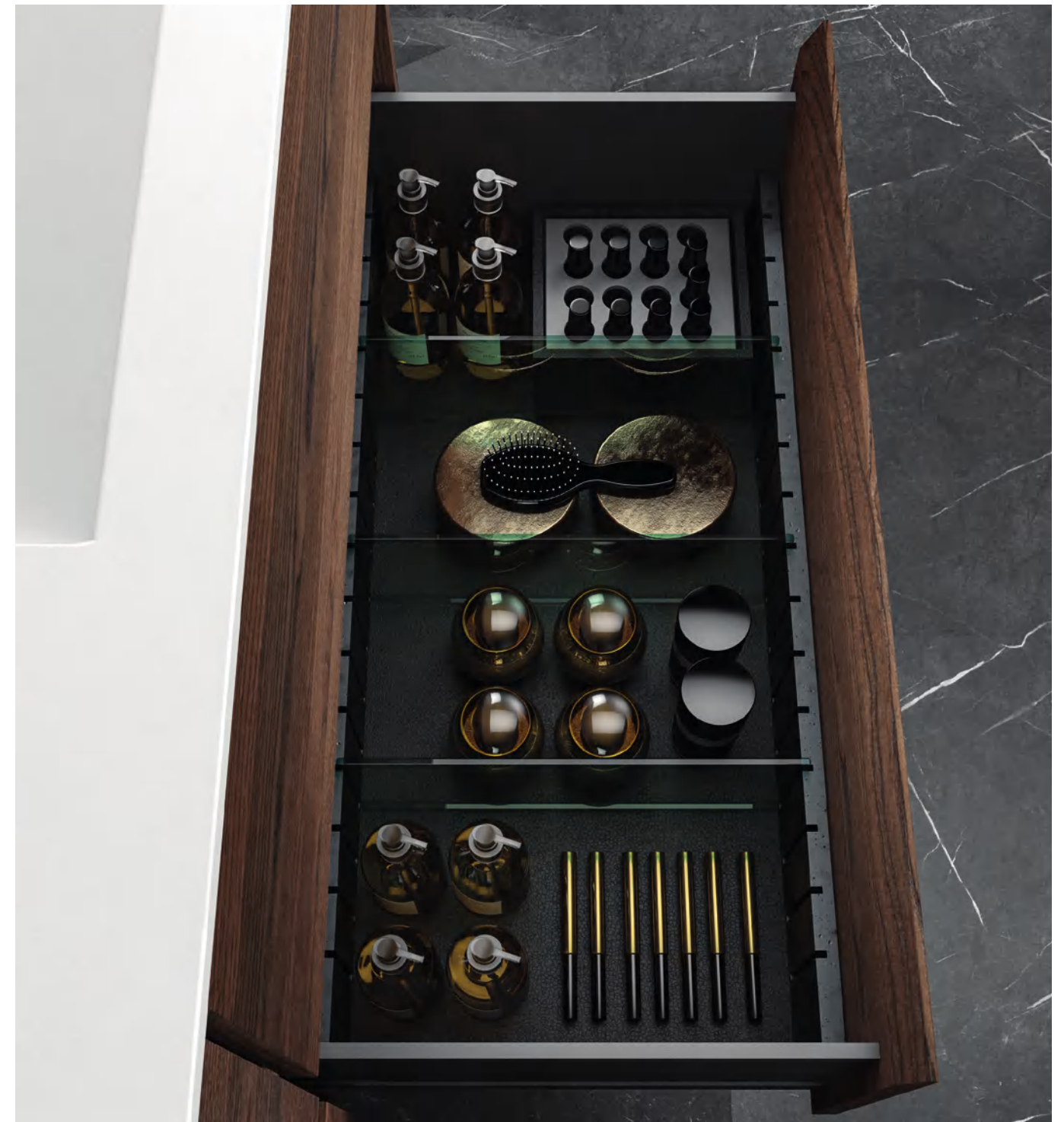
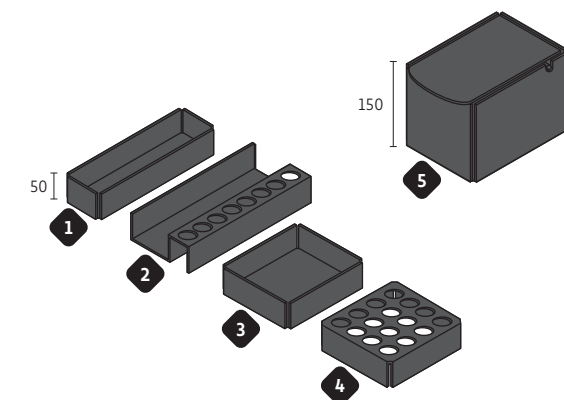

**tempered glass dividers**

Ref.:	Drawer depth	RRP
F620NN035	35	139,32
F620NN040	40	157,90

- 3 smoked glass dividers and 2 110 cm slotted strips.
- Easy installation.
- See page 06.

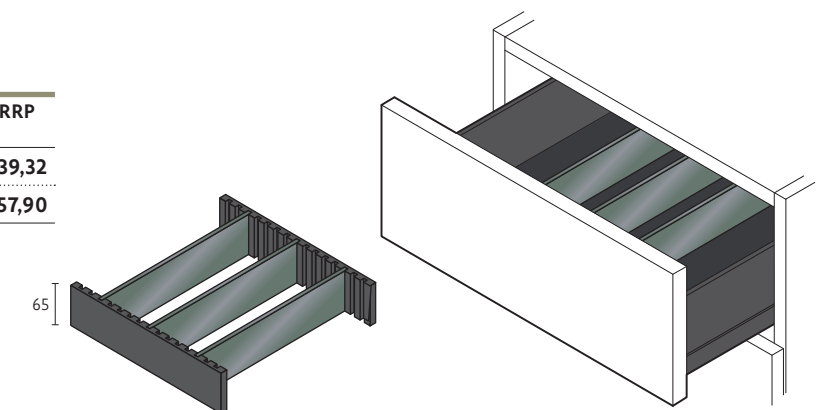

### DRAWER COMPLEMENTS

#### interior drawer

Ref.:	Front	RRP
S06	Metal XP	204,34
S89	Metal SCALA	204,34



- Front for recessed washbasin, min. height 48 cm.
- Front for sit-on washbasin and vanity units, min. height 32 cm.
- Washbasin units with cut-out.
- Optional interior drawer front same Kyrya® finish +£27,86

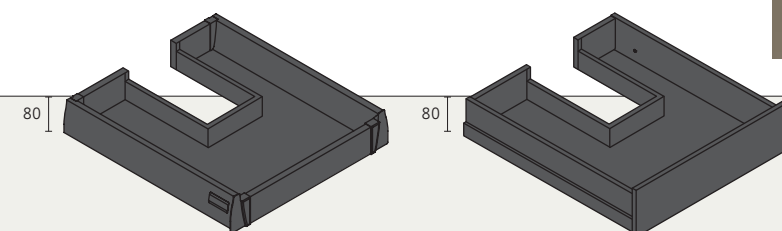
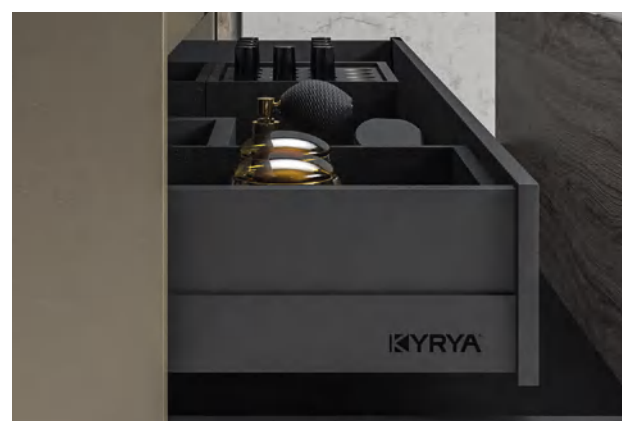

#### side glass for XP drawer

Ref.:	Finish	RRP
S13	Glass	104,03



- Minimum drawer height 32 cm.
- Not valid for drawer with cut out.

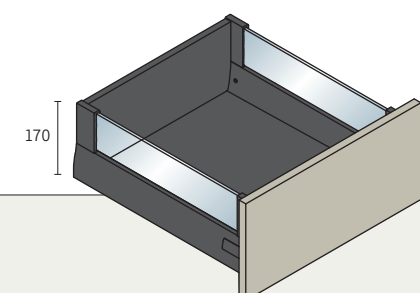

#### interior container

Ref.:	Measurement	RRP
P570NN	22 x 8 x 5h.	66,87



- Supplied unassembled.

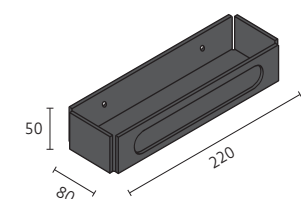

### ELECTRICAL ACCESSORIES

#### built-in speaker

Ref.:	Description	RRP
S59	Sound system	417,96



- Bluetooth receiver with built-in speaker.
- Hidden installation in the unit.
- Only valid for washbasin units with drawer.



#### built-in induction charger

Ref.:	Description	RRP
S61	Wireless charger	222,91



- Indicate hidden/surface and position on worktop.
- Not available in Pivstone® and hidden in Durian®.

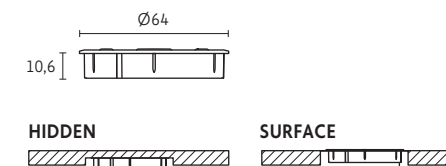

Sticker identifying the wireless charging location on the countertop.

#### built-in plug

Ref.:	Description	RRP
S60	Schuko plug	126,32



- Installed in drawer 3 cm from the side.
- Plugs adapted to each country.

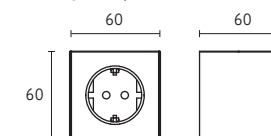

#### low level lighting

Ref.:	Description	RRP
S88	LED strip	232,20



- See availability depending on model.
- Supplied installed per module.



COUNTERTOP SUPPORTS

	Ref.:	Article	Measurement	Finish	RRP
	P070NN026	Set 2 brackets	26 x 2.5 x 8h.	Galvanised steel	105,88
	P070NN041	Set 2 brackets	41 x 2.5 x 8h.	Galvanised steel	126,32
	P120NN026	Set 3 brackets	26 x 2.5 x 8h.	Galvanised steel	144,89
	P120NN041	Set 3 brackets	41 x 2.5 x 8h.	Galvanised steel	165,33
	P160NN026	Set 2 brackets	26 x 2.5 x 8h.	Stainless steel	148,61
	P160NN041	Set 2 brackets	41 x 2.5 x 8h.	Stainless steel	176,47
<ul style="list-style-type: none"> <li>• Screws not included.</li> <li>• Must be used on Pivstone® countertops.</li> </ul>					
	P170NN026	Set 3 brackets	26 x 2.5 x 8h.	Stainless steel	232,20
	P170NN041	Set 3 brackets	41 x 2.5 x 8h.	Stainless steel	306,50
<ul style="list-style-type: none"> <li>• Screws not included.</li> <li>• Must be used on Pivstone® countertops.</li> </ul>					
	P060NN030	New hidden support	30 x 7 x 6h.	White	72,45
	P060NN040	New hidden support	40 x 7 x 6h.	White	102,17
	P050NN035	Set 2 angle supports	35 x 15	Chrome	176,47
	P050NN041	Set 2 angle supports	41 x 15	Chrome	195,05

LEGS / WHEELS

	Ref.:	Article	Measurement	Finish	RRP
	P090NX012	Set 2 L legs	12	Black Gloss silver	59,44
	P090NX024	Set 2 L legs	24	Black Gloss silver	70,59
	P08	Set 2 legs	40 x 24	Black Gloss silver	165,33
	P010NN012	Set 4 square legs	12	Gloss silver	37,15
	P010NN024	Set 4 square legs	24	Gloss silver	53,87
	P020NN002	Set 2 short legs	2.5	Chrome	72,45
 <p><b>COUNTERWEIGHT</b>                      • 30 cm +£46,44.                      • 40 cm +£55,73.                      • 50 cm +£74,30.</p>	P290NN012	Set 4 wheels	10	Grey	157,90
 <p><b>COUNTERWEIGHT</b>                      • 30 cm +£46,44.                      • 40 cm +£55,73.                      • 50 cm +£74,30.</p>	P280NN006	Set 4 wheels	6	Black	72,45
	P040N_030	Set 2 cone-shaped legs	30	Matt Select Lacquer Varnished wood	182,04
	P040N_045	Set 2 cone-shaped legs	45	Matt Select Lacquer Varnished wood	256,35
<ul style="list-style-type: none"> <li>• Straight and tilted fittings included.</li> <li>• Unit must be wall mounted.</li> </ul>					



TOWEL HOLDERS

verso towel holder

Ref.:	Measurement	RRP
P18	38.5 x 5 x 3.5h.	83,59

• Supplied to be installed with screws.

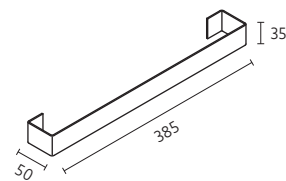

flat towel holder

Ref.:	Measurement	RRP
P14	30 x 8.5 x 11.5h.	92,88

• Only valid for washbasin units.  
• Installed with screws inside the unit.

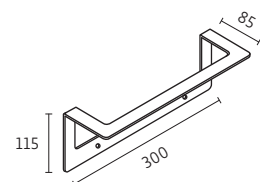

mix towel holder

Ref.:	Measurement	RRP
P15	30 x 6.5 x 11.5h.	92,88

• Only valid for washbasin units.  
• Supplied to be installed without screws.

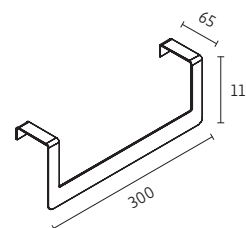

side towel holder

Ref.:	Measurement	RRP
P23	37 x 7 x 6.8h.	102,17

• Only valid for washbasin units.  
• Supplied to be installed on sides of 2 cm.

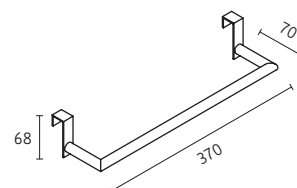

ACCESSORIES

hook

Ref.:	Measurement	RRP
P19	2 x 2.7 x 6.8h.	50,16

• Only valid for washbasin units.  
• Supplied to be installed on sides of 2 cm.

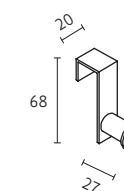

toilet roll holder

Ref.:	Measurement	RRP
P20	7.5 x 14.2 x 6.8h.	65,02

• Only valid for washbasin units.  
• Supplied to be installed on sides of 2 cm.

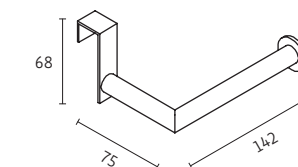

straightener holder

Ref.:	Measurement	RRP
P21	7.5 x 6.8h.	83,59

• Only valid for washbasin units.  
• Supplied to be installed on sides of 2 cm.

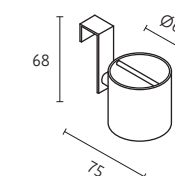

hairdryer holder

Ref.:	Measurement	RRP
P22	10 x 6.8h.	52,01

• Only valid for washbasin units.  
• Supplied to be installed on sides of 2 cm.

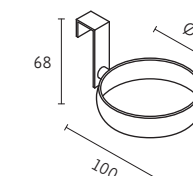

# GLASS FRONTS



*Black metal profile fronts with built-in handleless recess and smoked glass to fit almost any unit.*



## Scala drawer

GLASS FRONT FOR SCALA DRAWER INCLUDED

Ref.:	Width up to	Height up to	RRP
S56	60	32	235,92
	80	32	265,64
	100	32	293,50
S56	120	32	323,22
	60	48	269,35
	80	48	306,50
	100	48	341,80
	120	48	378,95

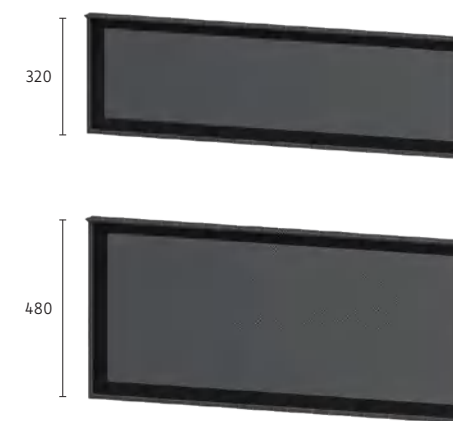

## door under washbasin/vanity unit

GLASS FRONT EXTRA COST

Ref.:	Width up to	Height	RRP
S57	50	48	258,21
	60	48	284,21
S57	50	64	287,93
	60	64	317,65

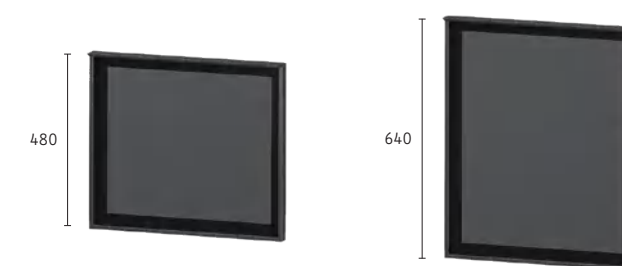

## high door

GLASS FRONT EXTRA COST

Ref.:	Width up to	Height up to	RRP
S57	30	70	245,20
	35	70	256,35
	40	70	269,35
	45	70	280,50

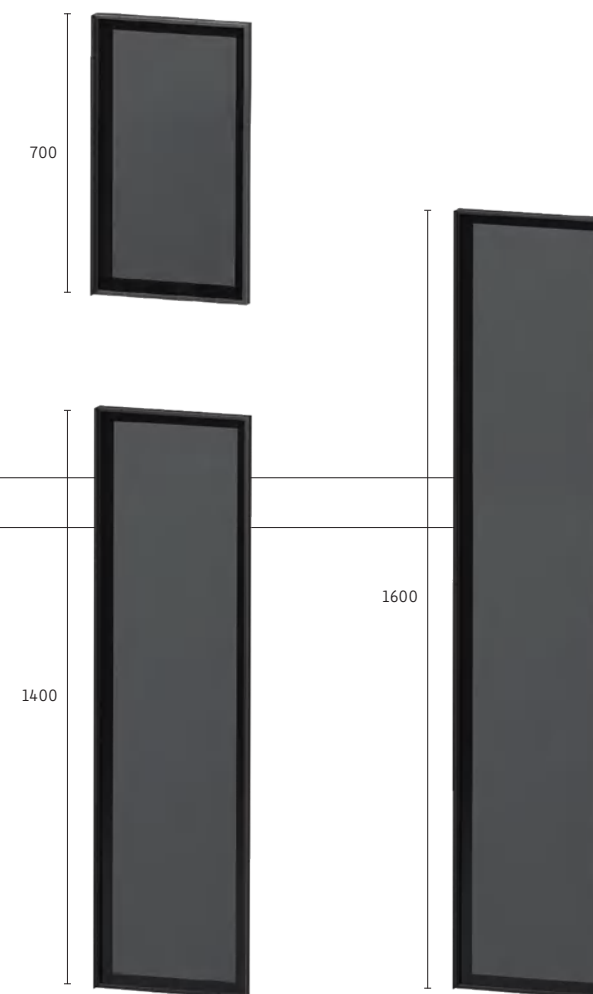

## column door

GLASS FRONT EXTRA COST

Ref.:	Width up to	Height up to	RRP
S57	25	140	326,94
	35	140	365,95
	45	140	403,10
S57	25	160	352,94
	35	160	395,67
	45	160	440,25

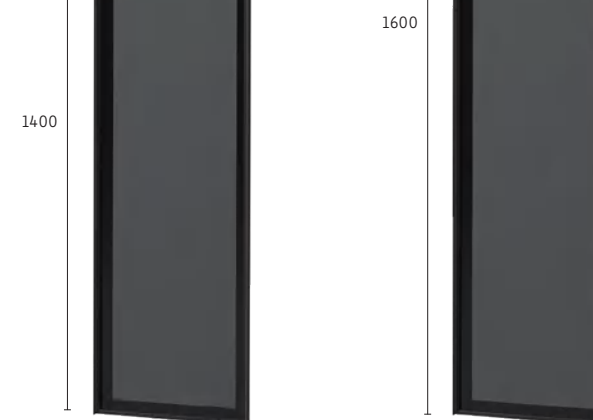

# METAL STRUCTURE



**46**  
DEPTH  
Up to 46 cm  
NO EXTRA COST

**47-55**  
DEPTH  
Up to 55 cm  
+20%

SEMI-POLISHED  
STEEL  
2x2 cm

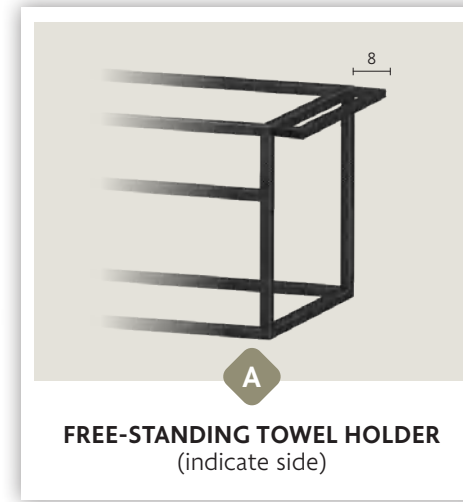

**FREE-STANDING TOWEL HOLDER**  
(indicate side)

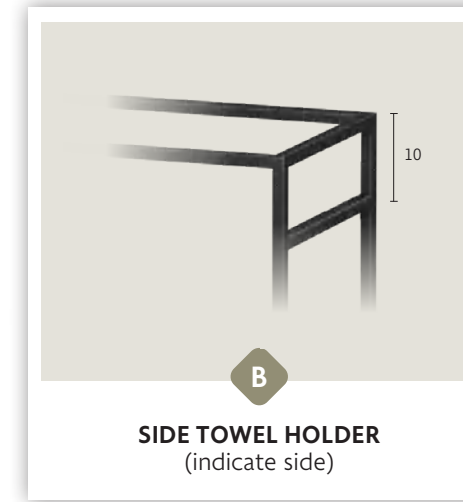

**SIDE TOWEL HOLDER**  
(indicate side)

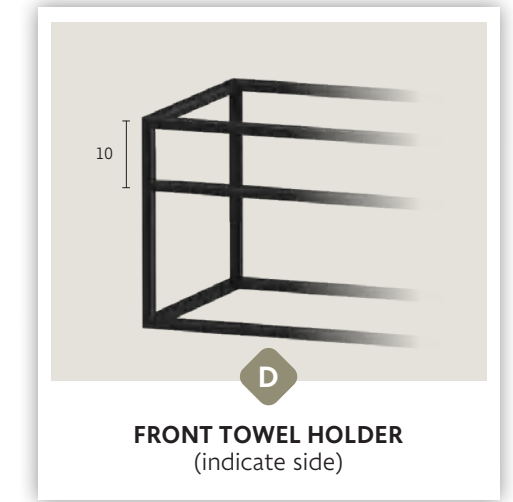

**FRONT TOWEL HOLDER**  
(indicate side)

## M wall-mounted structure

Ref.:	Width up to	Depth up to	Height up to	STRUCTURE	TOWEL HOLDER FREE-STANDING A
J03	60	46	40	724,46	111,46
	80	46	40	789,48	111,46
	100	46	40	882,36	111,46
	120	46	40	965,95	111,46

• Not suitable for inserting units between sides.



## XL wall-mounted structure

Ref.:	Width up to	Depth up to	Height up to	STRUC- TURE	TOWEL H. SIDE B	TOWEL H. FRONT D	TOWEL H. FREE-STAN. A
J02	60	46	55	863,78	57,59	152,32	111,46
	80	46	55	947,38	57,59	152,32	111,46
	100	46	55	1.068,12	57,59	152,32	111,46
	120	46	55	1.114,56	57,59	152,32	111,46

• Not suitable for inserting units between sides.  
• Standard side towel holder 12 cm from the countertop. Indicate side.  
• Standard front towel holder 12 cm from the countertop.

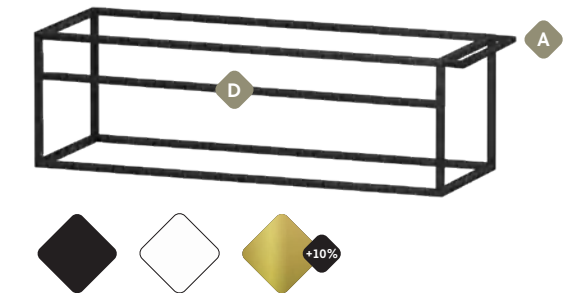

## floor-standing structure

Ref.:	Width up to	Depth up to	Height up to	STRUC- TURE	TOWEL H. SIDE B	TOWEL H. FRONT D	TOWEL H. FREE-STAN. A
J01	60	46	88	817,34	57,59	152,32	111,46
	80	46	88	882,36	57,59	152,32	111,46
	100	46	88	993,82	57,59	152,32	111,46
	120	46	88	1.058,83	57,59	152,32	111,46
	140	46	88	1.123,85	57,59	152,32	111,46

• Not suitable for inserting units between sides.  
• Leg height 12 cm, for other sizes please ask.



METAL STRUCTURE COMPLEMENTS

top towel holder

Ref.:	Width up to	Height up to	Profile	RRP
J07	60	90	2x2	538,70

- Screws not included.
- Fixed distribution.

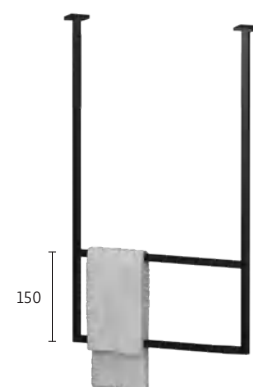
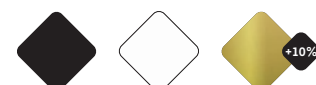

top panel 3 sides extra cost

Ref.:	Width up to	Depth up to	Height up to	FANTASY	ARLUX	SELECT LAC. MATT FENIX	WOOD
F31	60	46	10	479,26	508,98	600,00	637,16
	80	46	10	499,69	538,70	631,58	672,45
	100	46	10	527,56	561,00	661,31	705,89
	120	46	10	559,14	600,00	704,03	754,19

- Minimum standard height 2+10+2.
- Supplied installed.
- Price includes towel holders.

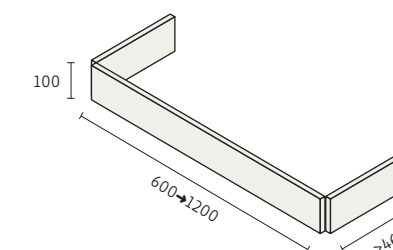

floor-standing towel holder

Ref.:	Width up to	Height up to	Profile	RRP
J06	60	180	2x2	724,46

- Fixed distribution.
- Not wall-mounted.

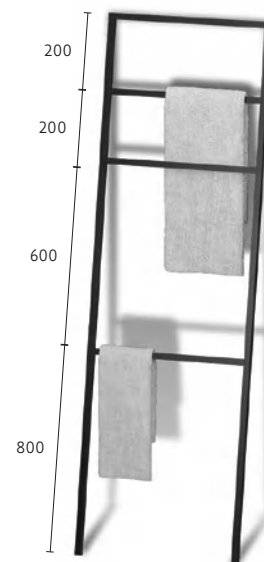
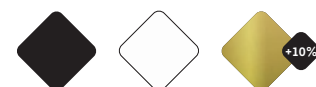

extra for removable

Ref.:	Width up to	Depth up to	Height up to	FANTASY	ARLUX	SELECT LAC. MATT FENIX	WOOD
F32	80	46	100	410,53	503,41	605,58	668,74
	100	46	100	466,26	577,71	696,60	770,90
	120	46	100	540,56	678,02	817,34	908,37

- Supplied installed.

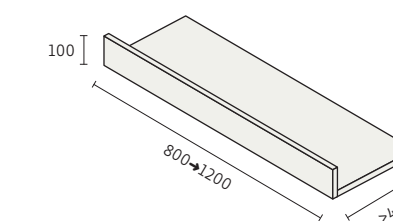

countertop side support structure

Ref.:	Height up to	Depth up to	Profile	RRP
J04	30	46	2x2	232,20
J05	88	46	2x2	343,66

- Wall mounting.
- J05 optional towel holders A and B.

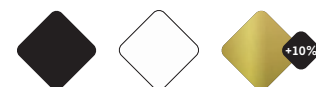

base countertop extra cost

Ref.:	Width up to	Depth up to	Thick-ness	FANTASY	ARLUX	SELECT LAC. MATT FENIX	WOOD
F22	60	51	1.9	137,46	176,47	219,20	243,35
	80	51	1.9	161,61	208,05	256,35	287,93
	100	51	1.9	189,48	245,20	302,79	339,94
	120	51	1.9	226,63	293,50	364,09	406,81

- Supplied separately.

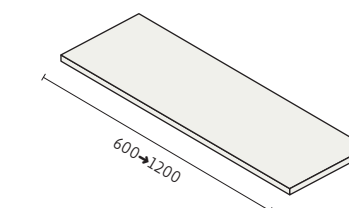

# 06A



**RAL LACQUER**  
MATT/GLOSS +15%  
METALLIC +20%

## WALL UNITS BASIC & DECORATIVE UNITS

Unless otherwise stated, the front panel is supplied with a straight door and recessed bases.

The interior shelves are 1.6 cm thick.

The handle is supplied in vertical position.  
Change of size or position +£46,44/module.

Minimum depth 15 cm (door included).

The number of shelves depends on the height of the module:  
1 shelf 40→59 cm / 2 shelves 60→94 cm.

3-position rack not available with Push opening.



**3-POSITION RACK**  
+£37,15



**GLASS SHELF**  
+£53,87/unit



**INTERIOR SHELF EXTRA**  
+£46,44



**MIRROR INT./EXT.**  
+£92,88/unit



**BOTTOM LED**  
+£232,20



**INSIDE SOCKET**  
+£126,32



TECH. DATA SHEETS



+£37,15



+£53,87



+£46,44

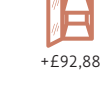

+£92,88



+£126,32

### 1 door

Ref.:	Width up to	Depth up to	Height up to	FANTASY	ARLUX	SELECT LAC. MATT FENIX	WOOD
A02	30	19	70	300,93	380,81	453,25	508,98
	35	19	70	319,51	401,24	475,55	533,13
	40	19	70	338,08	423,53	495,98	555,42
	45	19	70	377,09	477,40	533,13	637,16

• Indicate side.



+£37,15



+£53,87



+£46,44

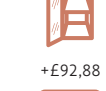

+£92,88

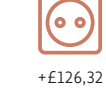

+£126,32

### 2 doors

Ref.:	Width up to	Depth up to	Height up to	FANTASY	ARLUX	SELECT LAC. MATT FENIX	WOOD
A10	40	19	70	408,67	455,11	587,00	663,16
	50	19	70	438,39	490,41	642,73	717,03
	60	19	70	464,40	527,56	665,02	731,89

• Not available with Gina handle.



+£37,15



+£53,87



+£46,44

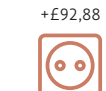

+£92,88



+£126,32

### cube 1 door

Ref.:	Width up to	Depth up to	Height up to	FANTASY	ARLUX	SELECT LAC. MATT FENIX	WOOD
A01	30	19	40	265,64	306,50	356,66	401,24
	40	19	40	289,79	332,51	393,81	456,97

• Indicate side.

• Shelf not included.

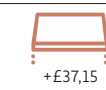

+£37,15



+£53,87



+£46,44



+£92,88



+£232,20



+£126,32

### 1 door / 1 drawer

Ref.:	Width up to	Depth up to	Height up to	FANTASY	ARLUX	SELECT LAC. MATT FENIX	WOOD
A18	30	24	70	466,26	609,29	668,74	778,33
	35	24	70	488,55	657,59	707,75	793,20
	40	24	70	507,12	685,45	750,47	843,35

• Indicate side.

• Drawer has ball bearing runners, fixed height 16 cm.

• Push not possible.

• Fixed height 16 cm and depth 24 cm.



More information and assembly instructions.



**1 door with decorative unit**

Ref.:	Width up to	Depth up to	Height up to	FANTASY	ARLUX	SELECT LAC. MATT FENIX	WOOD
A03	30	19	70	358,52	449,54	577,71	653,88
	40	19	70	401,24	477,40	646,44	713,32

- Indicate side.
- Door 1 cm with lower overhang.

**1 door / shelves**

Ref.:	Width up to	Depth up to	Height up to	FANTASY	ARLUX	SELECT LAC. MATT FENIX	WOOD
A28	40	19	70	462,54	534,99	759,76	817,34
	50	19	70	495,98	577,71	847,07	934,37
	60	19	70	518,27	614,87	936,23	1.027,25

- Door side overhang opening 1 cm.

**2 doors / 1 drawer**

Ref.:	Width up to	Depth up to	Height up to	FANTASY	ARLUX	SELECT LAC. MATT FENIX	WOOD
A19	40	24	70	587,00	746,76	811,77	915,80
	50	24	70	607,44	800,63	895,36	988,24
	60	24	70	644,59	854,50	973,38	1.081,12

- Drawer has ball bearing runners, fixed height 16 cm.
- Not available with Gina and Push handles.
- Fixed height 16 cm and depth 24 cm.

**decorative cube**

Ref.:	Width up to	Depth up to	Height up to	FANTASY	ARLUX	SELECT LAC. MATT FENIX	WOOD
A12	30	19	40	193,19	243,35	325,08	395,67
	40	19	40	213,62	273,07	356,66	421,68

- Visible top adjustment system.
- Front adjustment with optional metal trim.

**2 doors with decorative unit**

Ref.:	Width up to	Depth up to	Height up to	FANTASY	ARLUX	SELECT LAC. MATT FENIX	WOOD
A04	40	19	70	436,54	583,29	724,46	800,63
	50	19	70	473,69	639,01	763,47	830,35
	60	19	70	503,41	678,02	852,64	952,95

- Door 1 cm with lower overhang.
- Not available with Gina handle.

**2 horizontal cubes**

Ref.:	Width up to	Depth up to	Height up to	FANTASY	ARLUX	SELECT LAC. MATT FENIX	WOOD
A06	60	19	40	271,21	338,08	464,40	572,14
	70	19	40	302,79	360,37	488,55	603,72
	80	19	40	325,08	377,09	521,99	676,17

- Visible top adjustment system.
- Front adjustment with optional metal trim.
- Symmetrical cubes.

**2 doors with decorative unit**

Ref.:	Width up to	Depth up to	Height up to	FANTASY	ARLUX	SELECT LAC. MATT FENIX	WOOD
A05	90	19	40	510,84	689,17	813,63	902,79
	110	19	40	572,14	772,76	910,22	1.029,11

- Door side overhang opening 1 cm.
- Symmetrical cubes.

**3 horizontal cubes**

Ref.:	Width up to	Depth up to	Height up to	FANTASY	ARLUX	SELECT LAC. MATT FENIX	WOOD
A07	90	19	40	349,23	425,39	601,86	704,03
	110	19	40	388,24	462,54	663,16	761,62

- Visible top adjustment system.
- Front adjustment with optional metal trim.
- Symmetrical cubes.

### 2 vertical cubes

Ref.:	Width up to	Depth up to	Height up to	FANTASY	ARLUX	SELECT LAC. MATT FENIX	WOOD
A13	30	19	70	271,21	330,65	464,40	572,14
	40	19	70	302,79	351,09	488,55	603,72

- Visible top adjustment system.
- Front adjustment with optional metal trim.
- Symmetrical cubes.



### mirror open decorative unit

Ref.:	Width up to	Depth up to	Height up to	FANTASY	ARLUX	SELECT LAC. MATT FENIX	WOOD
A08	30	19	100	367,80	518,27	644,59	739,32
	40	19	100	406,81	570,28	702,17	815,49

- Open cube on both sides.



### 3 vertical cubes

Ref.:	Width up to	Depth up to	Height up to	FANTASY	ARLUX	SELECT LAC. MATT FENIX	WOOD
A47	30	19	100	339,94	419,82	564,71	704,03
	40	19	100	377,09	456,97	622,30	761,62

- Visible top adjustment system.
- Front adjustment with optional metal trim.
- Symmetrical cubes.



### wall unit 2 shelves

Ref.:	Width up to	Depth up to	Height up to	FANTASY	ARLUX	SELECT LAC. MATT FENIX	WOOD
A25	30	19	70	191,33	271,21	313,93	390,10
	40	19	70	230,34	299,07	352,94	447,68



### wall unit 3 shelves

Ref.:	Width up to	Depth up to	Height up to	FANTASY	ARLUX	SELECT LAC. MATT FENIX	WOOD
A26	30	19	100	235,92	334,37	380,81	484,83
	40	19	100	287,93	371,52	434,68	555,42



### INTERIOR DECORATIVE UNIT

#### 4 sides deco interior

Ref.:	Width up to	Depth up to	Height up to	FANTASY	ARLUX	SELECT LAC. MATT FENIX	WOOD
A121	30	24	40	137,46	174,61	215,48	261,92
	40	24	40	154,18	195,05	239,63	280,50

- 12 mm thickness for Lacquer and Wood.
- 19 mm thickness for Fantasia, Arlux and Fenix.
- Supplied mounted on the inside of its decorative part.



#### 5 sides deco interior

Ref.:	Width up to	Depth up to	Height up to	FANTASY	ARLUX	SELECT LAC. MATT FENIX	WOOD
A122	30	24	40	154,18	193,19	258,21	315,79
	40	24	40	170,90	217,34	286,07	338,08

- 12 mm thickness for Lacquer and Wood.
- 19 mm thickness for Fantasia, Arlux and Fenix.
- Supplied mounted on the inside of its decorative part.



# 06B



**RAL LACQUER**  
MATT/GLOSS +15%  
METALLIC +20%

## COLUMNS

Minimum drawer depth 32.5 cm.

The handleless front is supplied according to the model.

The interior shelves are 1.6 cm thick.

Maximum door height 160 cm.

If the height of the door is greater than 120 cm  
the grain of the Wood finish will be vertical.

Unless otherwise stated on the doors, the handle will be supplied  
in vertical position, change of size or position +£46,44/mod.

Decorative interior see page 81.

The number of shelves depends on the height of the module:  
1 shelf (40→59 cm) / 2 shelves (60→94 cm)  
3 shelves (95→138 cm) / 4 shelves (139→160 cm)

3-position rack not available with Push opening.



**3-POSITION  
RACK**  
+£37,15



**GLASS  
SHELF**  
+£53,87/unit



**INTERIOR  
SHELF EXTRA**  
+£46,44



**EXTRA  
DRAWER**  
+£148,61



**MIRROR  
INT./EXT.**  
+£130,03/unit



**LAUNDRY BASKET  
EXTRA**  
+£176,47



**METAL  
LAUNDRY BASKET**  
+£176,47

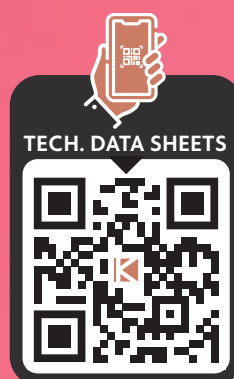

TECH. DATA SHEETS



+£37,15



+£53,87



+£46,44



+£130,03

### 1 door

Ref.:	Width up to	Depth up to	Height up to	FANTASY	ARLUX	SELECT LAC. MATT FENIX	WOOD
M03	25	24	140	449,54	542,42	702,17	800,63
	35	24	140	486,69	570,28	750,47	878,64
	45	24	140	527,56	607,44	834,06	962,24

- Indicate side.
- With handleless opening, the door is supplied 1 cm wider than the structure, also valid for any handle or Push.

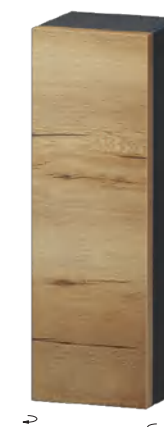

+£37,15



+£53,87



+£46,44



+£130,03

### 2 doors

Ref.:	Width up to	Depth up to	Height up to	FANTASY	ARLUX	SELECT LAC. MATT FENIX	WOOD
M04	25	24	140	533,13	650,16	813,63	910,22
	35	24	140	564,71	700,32	908,37	1.008,68
	45	24	140	613,01	759,76	1.016,11	1.164,72
M05	25	35	180	653,88	785,76	1.056,97	1.213,01
	35	35	180	713,32	839,64	1.161,00	1.322,61
	45	35	180	772,76	906,51	1.244,59	1.400,63

- Indicate side.



+£37,15



+£53,87



+£46,44



+£130,03

### 2 doors / 1 decorative unit

Ref.:	Width up to	Depth up to	Height up to	FANTASY	ARLUX	SELECT LAC. MATT FENIX	WOOD
M36	25	24	140	588,86	698,46	895,36	990,10
	35	24	140	618,58	739,32	1.012,39	1.110,84
	45	24	140	676,17	817,34	1.159,14	1.259,45
M46	25	35	180	707,75	865,64	1.075,55	1.188,86
	35	35	180	743,04	913,94	1.214,87	1.331,90
	45	35	180	811,77	1.010,53	1.391,34	1.512,09

- Indicate side. Cube flush with the structure always 30 cm.
- Optional decorative interior, see page 81.
- Bottom and top opening with overhang on decorative.



+£37,15



+£53,87



+£46,44



+£130,03

### 2 doors / 1 drawer

Ref.:	Width up to	Depth up to	Height up to	FANTASY	ARLUX	SELECT LAC. MATT FENIX	WOOD
M23	35	35	140	798,77	936,23	1.144,28	1.265,03
	45	35	140	871,21	1.029,11	1.285,46	1.389,48
M24	35	35	180	895,36	1.129,42	1.422,92	1.597,54
	45	35	180	960,38	1.213,01	1.588,25	1.855,74

- Indicate side.
- Column with drawer minimum depth 32.5 cm.
- Fixed drawer size 16 cm.



### 1 door / 1 drawer



Ref.:	Width up to	Depth up to	Height up to	FANTASY	ARLUX	SELECT LAC. MATT FENIX	WOOD
M22	35	35	140	733,75	902,79	1.157,28	1.311,47
	45	35	140	787,62	990,10	1.278,03	1.448,93
M25	35	35	180	791,34	1.003,10	1.382,05	1.564,10
	45	35	180	850,78	1.060,69	1.554,81	1.762,86

- Indicate side.
- Column with drawer minimum depth 32.5 cm.



### 4 doors

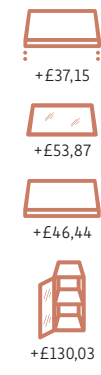

Ref.:	Width up to	Depth up to	Height up to	FANTASY	ARLUX	SELECT LAC. MATT FENIX	WOOD
M42	50	24	140	835,92	1.029,11	1.216,73	1.499,08
	65	24	140	908,37	1.133,14	1.333,76	1.601,25
	80	24	140	977,10	1.231,59	1.424,78	1.686,70
M43	50	35	180	1.006,82	1.231,59	1.471,22	1.788,87
	65	35	180	1.094,13	1.331,90	1.590,11	1.859,46
	80	35	180	1.183,29	1.426,64	1.679,27	1.954,20

- Not available with Gina handle.

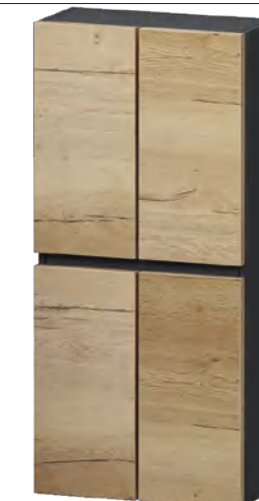

### 1 door / 1 decorative unit



Ref.:	Width up to	Depth up to	Height up to	FANTASY	ARLUX	SELECT LAC. MATT FENIX	WOOD
M37	25	24	140	460,68	605,58	921,37	1.077,41
	35	24	140	508,98	655,73	1.012,39	1.175,86
	45	24	140	562,85	741,18	1.118,28	1.315,18

- Indicate side.
- Cube flush with the structure with fixed height of 30 cm.
- Option decorative interior, see page 81.
- Bottom opening with overhang on decorative.



### 1 door / 3 decorative units



Ref.:	Width up to	Depth up to	Height up to	FANTASY	ARLUX	SELECT LAC. MATT FENIX	WOOD
M38	25	24	180	635,30	861,93	1.278,03	1.437,78
	35	24	180	694,74	947,38	1.415,49	1.588,25
	45	24	180	752,33	1.027,25	1.543,67	1.738,71

- Indicate side.
- Cubes flush with the structure always 50%.
- Top opening with overhang on decorative.
- Visible top adjustment system.



### 2 doors



Ref.:	Width up to	Depth up to	Height up to	FANTASY	ARLUX	SELECT LAC. MATT FENIX	WOOD
M32	50	24	140	692,88	837,78	1.014,25	1.201,87
	65	24	140	757,90	913,94	1.114,56	1.263,17
	80	24	140	817,34	977,10	1.209,30	1.357,91

- Opening only with Push or handle.
- Not available with Gina handle.



### 1 door / shelf



Ref.:	Width up to	Depth up to	Height up to	FANTASY	ARLUX	SELECT LAC. MATT FENIX	WOOD
M30	50	24	140	566,57	837,78	1.140,57	1.404,35
	60	24	140	613,01	897,22	1.261,31	1.526,95

- Door 1 cm wider than the structure.



### 2 doors / 1 decorative unit



Ref.:	Width up to	Depth up to	Height up to	FANTASY	ARLUX	SELECT LAC. MATT FENIX	WOOD
M33	50	24	140	698,46	897,22	1.222,30	1.413,63
	65	24	140	756,04	980,81	1.322,61	1.474,93
	80	24	140	817,34	1.049,54	1.417,35	1.567,81

- Cube flush with the structure.
- Option decorative interior, see page 81.
- Bottom opening with overhang on decorative.
- Not available with Gina handle.

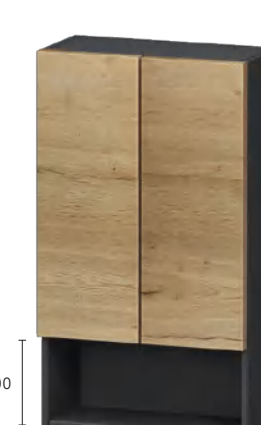

### mixed



Ref.:	Width up to	Depth up to	Height up to	FANTASY	ARLUX	SELECT LAC. MATT FENIX	WOOD
M31	50	24	140	696,60	975,24	1.320,75	1.651,41
	60	24	140	752,33	1.034,68	1.400,63	1.814,88

- Cubes flush with the structure.
- Visible top adjustment system.
- Door 1 cm wider than the structure.



mirror open decorative unit

Ref.:	Width up to	Depth up to	Height up to	FANTASY	ARLUX	SELECT LAC. MATT FENIX	WOOD
M53	30	24	140	497,84	639,01	850,78	1.029,11
	40	24	140	557,28	707,75	926,94	1.123,85

• Open cube on both sides.



side decorative unit

-  +£37,15
-  +£53,87
-  +£46,44
-  +£130,03

Ref.:	Width up to	Depth up to	Height up to	FANTASY	ARLUX	SELECT LAC. MATT FENIX	WOOD
M34	30→39	50	180	977,10	1.318,90	1.905,90	2.414,88
	40	50	180	1.034,68	1.439,64	2.121,38	2.643,36



decorative unit 4 cubes

Ref.:	Width up to	Depth up to	Height up to	FANTASY	ARLUX	SELECT LAC. MATT FENIX	WOOD
M21	30	24	140	388,24	525,70	752,33	988,24
	40	24	140	438,39	551,71	787,62	1.042,11

• Visible top adjustment system.



decorative unit 8 cubes

Ref.:	Width up to	Depth up to	Height up to	FANTASY	ARLUX	SELECT LAC. MATT FENIX	WOOD
M45	50	24	140	486,69	655,73	1.012,39	1.229,73
	60	24	140	533,13	726,32	1.127,56	1.391,34
	70	24	140	588,86	796,91	1.220,44	1.519,52

• Visible top adjustment system.



broom cabinet

Ref.:	Width up to	Depth up to	Height up to	FANTASY	ARLUX	SELECT LAC. MATT FENIX	WOOD
M47	50	35	180	1.354,19	1.400,63	2.203,11	2.307,14
	65	35	180	1.385,77	1.443,36	2.398,16	2.504,04
	80	35	180	1.428,49	1.486,08	2.593,21	2.706,52

• Indicate shelf position side.



washing machine and dryer

Ref.:	Width up to	Depth up to	Height up to	FANTASY	ARLUX	SELECT LAC. MATT FENIX	WOOD
M48	70	65→70	200	1.419,21	1.448,93	2.736,24	3.239,65
	80	65→70	200	1.441,50	1.473,08	2.858,85	3.377,12

- 4 symmetrical doors.
- Removable plinth.
- Not valid with Push and Gina opening.



# ROTATING COLUMNS

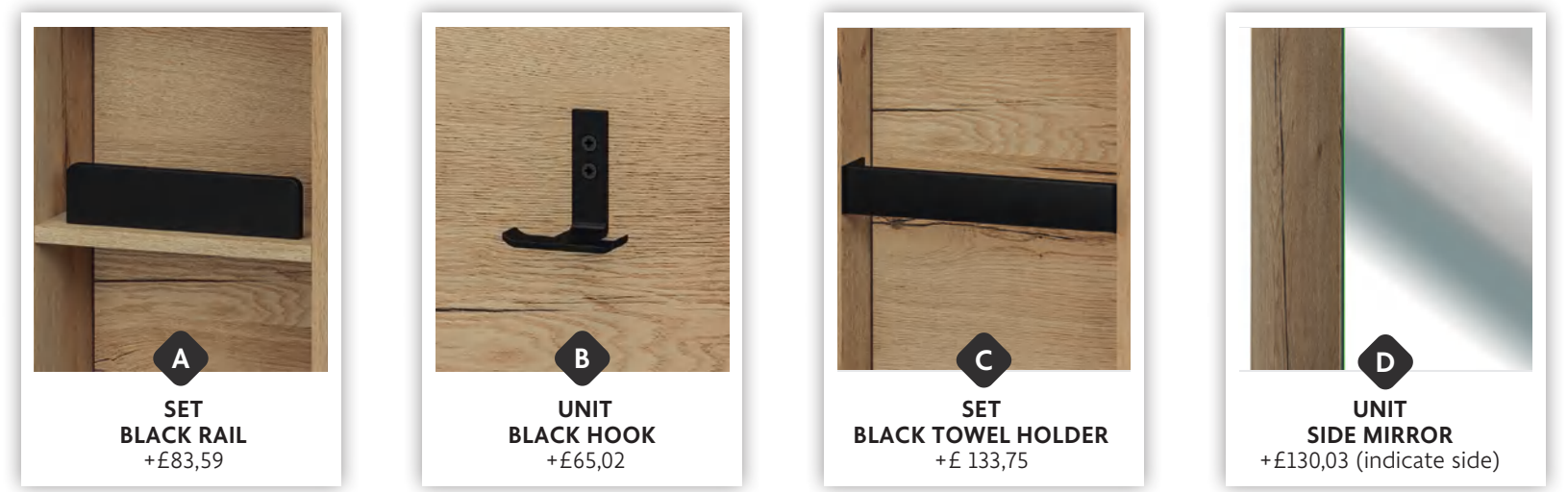

rotating column 5 cubes and mirror

Ref.:	Width	Depth	Height	FANTASY	ARLUX	SELECT LAC. MATT FENIX	WOOD
M54	29	29	184	1.004,96	1.108,99	1.333,76	1.497,23
M541	29	29	204	1.144,28	1.265,03	1.547,38	1.736,86

- Total depth (unit + fittings) 38 cm.
- Depth with unit in diagonal position 45 cm.

rotating column 5 cubes

Ref.:	Width	Depth	Height	FANTASY	ARLUX	SELECT LAC. MATT FENIX	WOOD
M55	29	29	184	874,93	978,96	1.580,82	1.788,87
M551	29	29	204	1.014,25	1.134,99	1.833,45	2.074,94

- Total depth (unit + fittings) 38 cm.
- Depth with unit in diagonal position 45 cm.



More information and assembly instructions.



# MIRRORS CABINETS LIGHTING

- INFINITY LED COLLECTION ..... p.92
- FRAME COLLECTION ..... p.94
- FORMS COLLECTION ..... p.96
- PENDENT COLLECTION ..... p.100
- STRAIGHT METAL COLLECTION ..... p.102
- CURVED METAL COLLECTION ..... p.104
- CONTOUR COLLECTION ..... p.106
- SAND COLLECTION ..... p.108
- COMBI COLLECTION ..... p.110
- LACK COLLECTION ..... p.112
- CLASSIC COLLECTION ..... p.114
- DECO COLLECTION ..... p.120
- DOUBLE MIRRORED CABINETS ..... p.122
- MIRRORED DOOR CABINETS ..... p.124
- LIGHTING ..... p.126



+10% every 10 cm

**LARGER SIZES.**  
Only on indicated mirrors.



**BACKLESS MIRROR.**  
Maximum width 120 cm.



+£55,73 net price

**SEPERATE MIRROR.**  
Special packaging and transport.



**BACK THICKNESS 19/25 mm.**  
Allows formats up to 200 cm depending on the model.



+£269,35/L.m.

**INTERIOR LIGHTING TOP LED.**  
Minimum chargeable 1 metre.



**TEMPERATURE 4000°K.**  
Option 3000°K without increase.



+£120,74/unit

**ON/OFF INFRARED MOTION SENSOR ON THE SIDE.**  
Supplied on the right. For correct operation it needs at least 10 cm obstacle free.



+£167,18/unit

**ON/OFF TOUCH SENSOR ON THE FRONT WITH LED INDICATOR.**  
Not compatible with SEGURGLASS or magnification mirror.



**THE WOOD GRAIN IS ALWAYS HORIZONTAL.**



+£111,46/unit

**THE ANTIMIST DEVICE 40x40**  
For sizes larger than 60x60  
Consumption 36W.



+£260,06/unit

**BUILT-IN 5X MAGNIFICATION MIRROR**  
Positioned 10 cm from the edge and height centred. Left/right option. Not compatible with SEGURGLASS or front sensor.



+£501,55/unit

**BUILT-IN AND ILLUMINATED 5X MAGNIFICATION MIRROR**  
Positioned 10 cm from the edge and centred in height. Left/right option. Not compatible with SEGURGLASS or front sensor.



**DIRECTION CHANGE**  
No extra charge in indicated mirrors.



+£139,32/unit

**SEURGLASS**  
In the event of breakage, it prevents the glass from falling out.

COLLECTION

# INFINITY LED



## infinity top

Ref.:	Width up to	Height	RRP
E700	70	80	666,88
	80	80	683,60
	90	80	704,03
	100	80	720,75
	120	80	921,37
	140	80	960,38

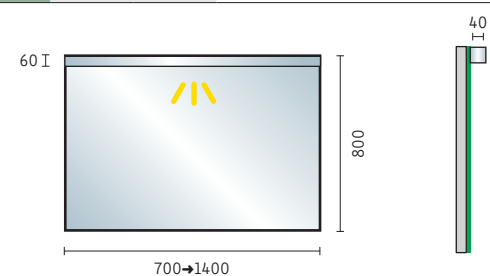

+10%x10



+£120,74



+£111,46

## infinity line

Ref.:	Width up to	Height	RRP
E710	70	80	646,44
	80	80	666,88
	90	80	681,74
	100	80	702,17
	120	80	902,79
	140	80	941,80

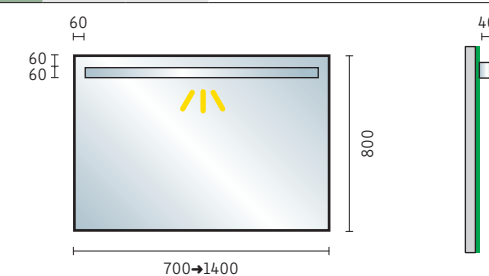

+10%x10



+£120,74



+£111,46





COLLECTION  
**FRAME**



**octogonal**

Ref.:	Diameter	Perimeter 1.5	Perimeter 1.5 + ambient light
E720	Ø60	364,09	648,30
	Ø80	455,11	774,62
	Ø100	561,00	913,94

• 1.5 cm black profile painted under the glass.

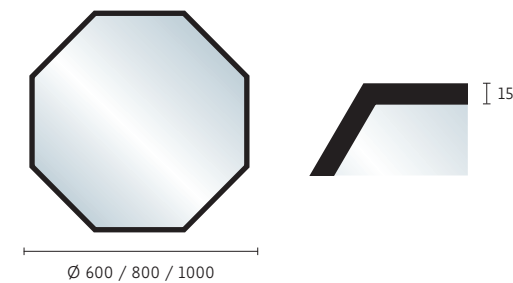

**round**

Ref.:	Diameter	Perimeter 1.5	Perimeter 1.5 + ambient light
E730	Ø60	416,10	700,32
	Ø80	510,84	828,49
	Ø100	611,15	964,09

• 1.5 cm black profile painted under the glass.

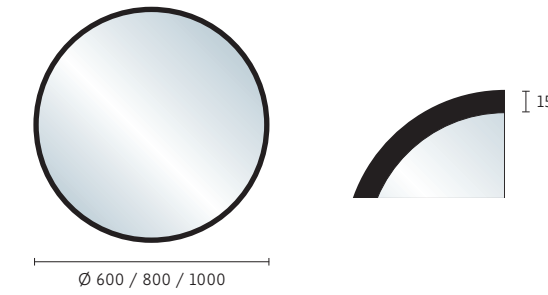

**hexagonal**

Ref.:	Width	Perimeter 1.5	Perimeter 1.5 + ambient light
E740	60	338,08	622,30
	80	419,82	739,32
	100	516,41	871,21

• 1.5 cm black profile painted under the glass.

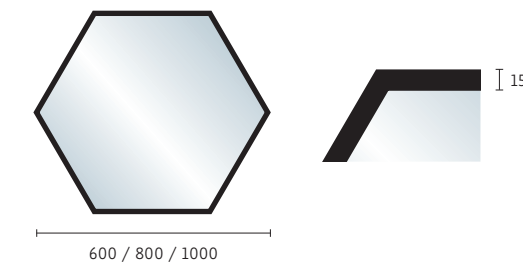

**rectangular**

Ref.:	Width	Height	Perimeter 1.5	Perimeter 1.5 + ambient light
E750	80	70	360,37	644,59
	90	70	382,67	702,17
	100	70	395,67	750,47
	120	70	440,25	837,78

• 1.5 cm black profile painted under the glass.

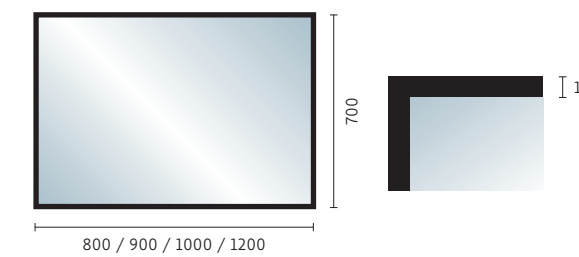

+£120,74  
+£111,46

+£111,46

+£120,74  
+£111,46

+£120,74  
+£111,46

VERTICAL POSITION  
E751



COLLECTION  
**FORMS**



**hexagonal non bevelled**

Ref.:	Width	Non bevelled	Non bevelled + ambient light
E770	60	248,92	549,85
	80	284,21	624,15
	100	328,80	705,89

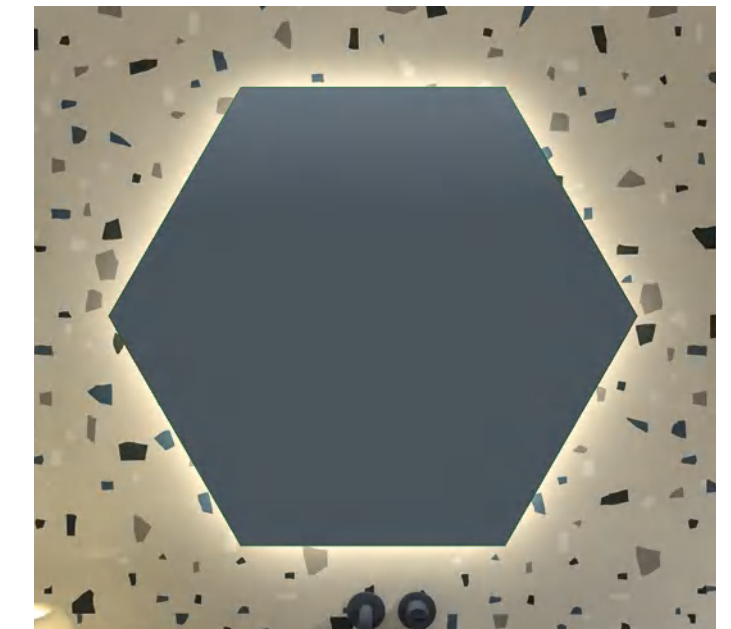
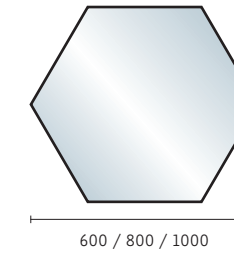

**octagonal non bevelled**

Ref.:	Width	Non bevelled	Non bevelled + ambient light
E780	60	256,35	557,28
	80	295,36	635,30
	100	341,80	718,89

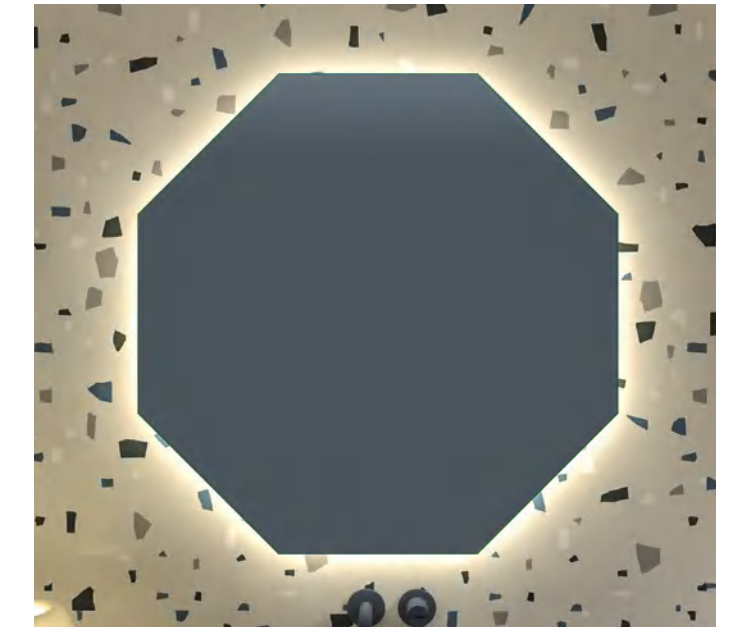
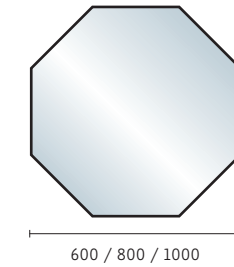

**always**

Ref.:	Width	Height	Non bevelled	Non bevelled + ambient light
E761	60	80	299,07	620,44
	60	100	321,36	681,74
	80	80	330,65	728,18
	80	100	356,66	802,48
	80	120	382,67	876,79

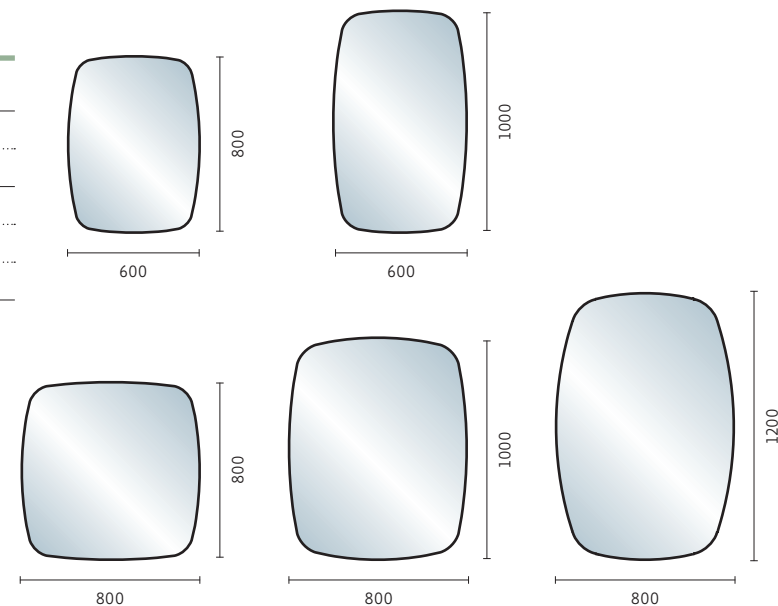

**rock 21 non bevelled**

Ref.:	Width	Height	Non bevelled	Non bevelled + ambient light
E850	35	34	195,05	553,56
	75	73	310,22	659,45
	95	92	351,09	735,61

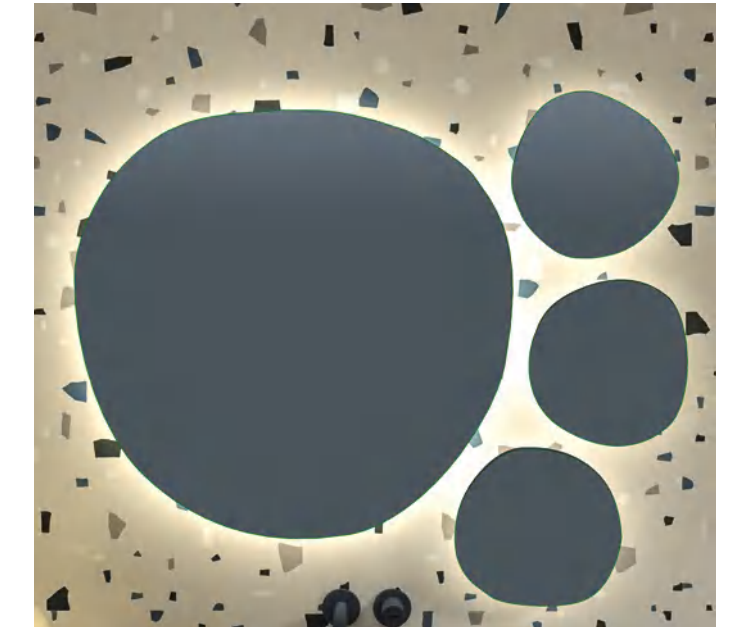
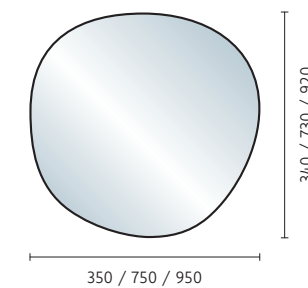

### moon non bevelled

Ref.:	Diameter	Non bevelled	Non bevelled + ambient light
E590	Ø60	343,66	702,17
	Ø70	364,09	726,32
	Ø80	378,95	754,19
	Ø90	425,39	776,48
	Ø100	466,26	809,91
	Ø110	559,14	912,08

+£111,46

### rise non bevelled

Ref.:	Width	Height	Non bevelled	Non bevelled + ambient light
E790	100	80	380,81	681,74
	110	90	410,53	748,61
	120	100	449,54	824,77

• Horizontal cut-out in the lower part, ideal for completing with the F17 railing shelf, see page 53.

+£111,46

### moon bevel 3

Ref.:	Diameter	Bevel 3	Bevel 3 + ambient light
E330	Ø80	456,97	815,49
	Ø90	499,69	867,50
	Ø100	534,99	910,22
	Ø110	609,29	973,38

Bevel detail.

+£111,46

### elliptic bevel 0.5

Ref.:	Width	Height	Bevel 0.5	Bevel 0.5 + ambient light
E320	90	60	360,37	765,33
	105	70	443,97	834,06

Bevel detail.

VERTICAL POSITION E321

+£111,46

### eclipse bevel 1

Ref.:	Diameter	Bevel 1	Bevel 1 + ambient light
E350	Ø90	874,93	1.244,59
	Ø100	971,52	1.331,90

• Includes magnification mirror located 10 cm from the edge.

Bevel detail.

+£111,46

### sail bevel 0.5

Ref.:	Width	Height	Bevel 0.5	Bevel 0.5 + ambient light
E380	65	90	365,95	752,33

Bevel detail.

HORIZONTAL POSITION E381

+£111,46



COLLECTION  
**PENDENT**



**nubia**

Ref.:	Diameter	Depth	Lighting	RRP
E810	Ø60	4	no	724,46
	Ø70	4	no	789,48
E860	Ø60	4	yes	1.019,82
	Ø70	4	yes	1.086,70

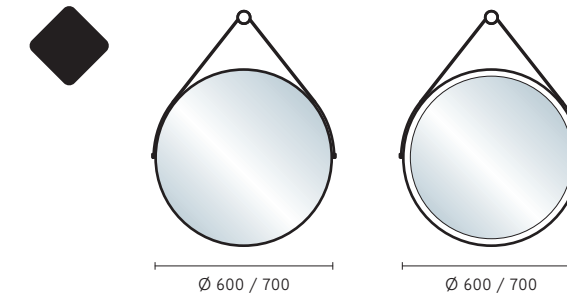

**india**

Ref.:	Width	Height	Profile	RRP
E650	60	90	2x2	917,65

- 2-sided mirror with SECURGLASS.
- Only valid for framed top.
- Screws not included.

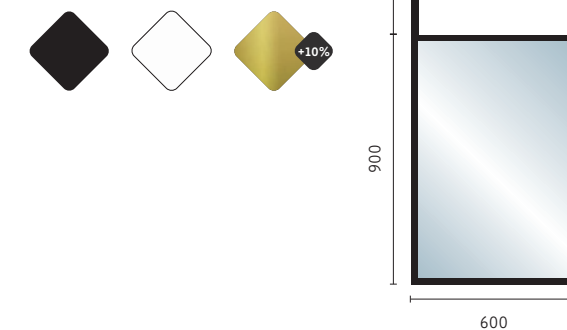

**nadia**

Ref.:	Width	Height	Profile	RRP
E660	50	90	3	956,66

- 2-sided mirror with SECURGLASS.
- Only valid for framed top.
- Screws not included.

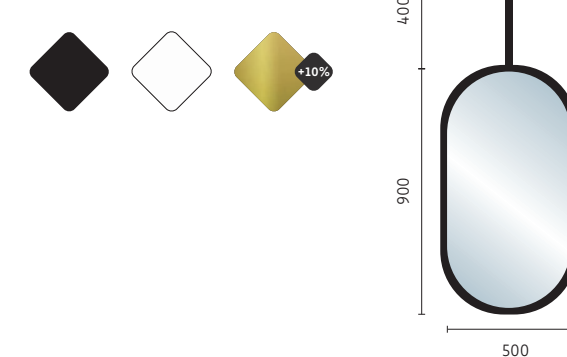

COLLECTION  
**STRAIGHT METAL**

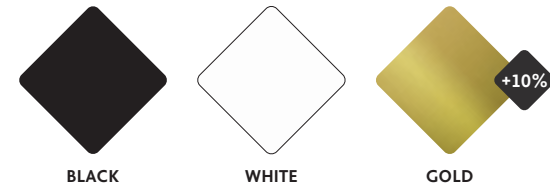

**indra led sandblasted (vertical)**

Ref.:	Width up to	Height	Depth 5
E530	70	70	910,22
	80	70	941,80
	90	70	997,53
	100	70	1.043,97
	120	70	1.231,59
	140	70	1.361,62

- +10% x10
- +£111,46
- +£167,18

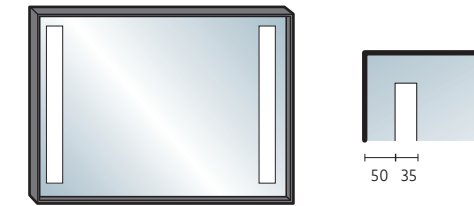

**indra led sandblasted (top)**

Ref.:	Width up to	Height	Depth 5
E540	70	70	1.021,68
	80	70	1.081,12
	90	70	1.125,71
	100	70	1.179,58
	120	70	1.226,02
	140	70	1.348,62

- +10% x10
- +£111,46
- +£167,18

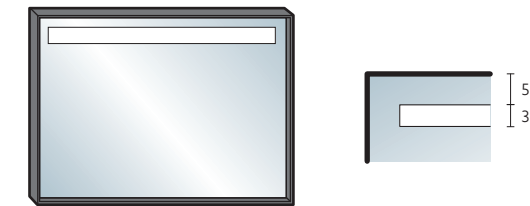

**indra led sandblasted (perimeter)**

Ref.:	Width up to	Height	Depth 5
E550	70	70	986,39
	80	70	1.010,53
	90	70	1.051,40
	100	70	1.108,99
	120	70	1.162,86
	140	70	1.257,60

- +10% x10
- +£111,46
- +£167,18

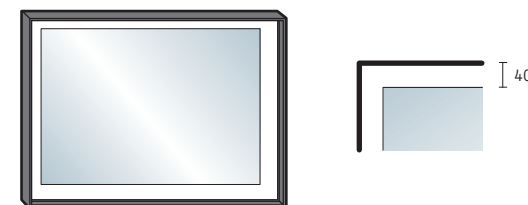

VERTICAL POSITION E551

**indra**

Ref.:	Width up to	Height	Depth 3	Depth 5
E500	70	70	609,29	639,01
	80	70	629,73	665,02
	90	70	652,02	696,60
	100	70	672,45	713,32
	120	70	737,47	761,62
	140	70	774,62	824,77

- +10% x10
- +£111,46



VERTICAL POSITION E501



COLLECTION  
**CURVED METAL**

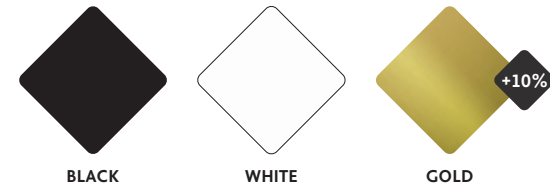

**uma**

Ref.:	Diameter	Depth <sub>3</sub>	Depth <sub>5</sub>
E510	Ø80	678,02	705,89
	Ø90	700,32	731,89
	Ø100	-	776,48

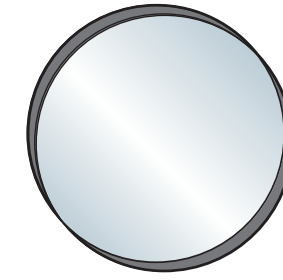

**naya led sandblasted (deco)**

Ref.:	Width	Height	Depth
E580	50	90	858,21

• Vertically reversible.

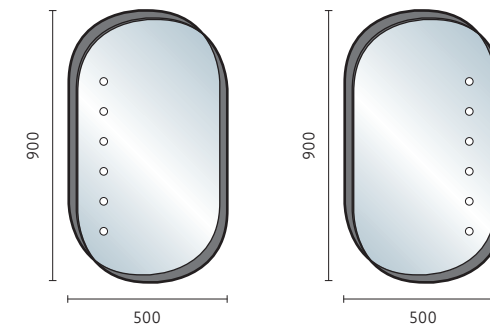

**uma led sandblasted (perimeter)**

Ref.:	Diameter	Depth
E560	Ø80	1.023,54
	Ø90	1.092,27
	Ø100	1.168,43

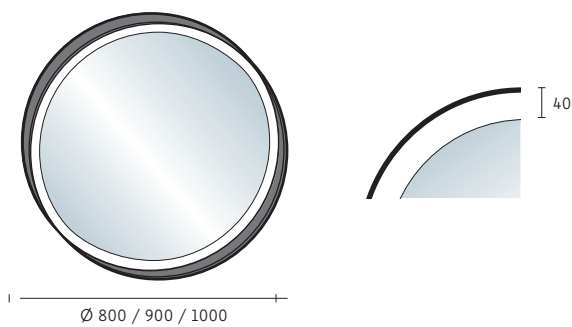

**naya**

Ref.:	Width	Height	Depth <sub>3</sub>	Depth <sub>5</sub>
E520	50	90	635,30	672,45

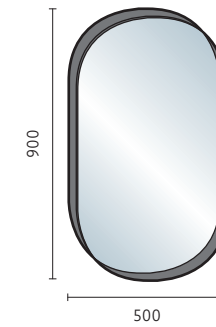

COLLECTION  
**CONTOUR**



**aura**

Ref.:	E420		E600	
Diameter	Perimeter 3 transparent	Perimeter 3 transp.+light	Perimeter 4 sandblasted	Perimeter 4 sand.+light
Ø80	499,69	863,78	451,40	817,34
Ø90	542,42	882,36	473,69	852,64
Ø100	575,86	932,52	521,99	880,50
Ø110	679,88	1.042,11	614,87	964,09

  
+£111,46

  
+£167,18

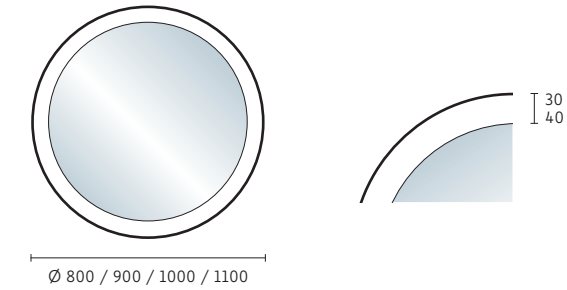

SANDBLASTED PERIMETER.

**shine**

Ref.:	E430		E610	
Measure. up to	Perimeter 3 transparent	Perimeter 3 transp.+light	Perimeter 4 sandblasted	Perimeter 4 sand.+light
80 x 70	484,83	863,78	460,68	828,49
90 x 70	518,27	900,94	499,69	871,21
100 x 70	533,13	934,37	514,56	895,36
120 x 70	620,44	1.004,96	598,15	951,09
140 x 70	692,88	1.099,70	661,31	1.021,68

  
+£111,46

  
+£167,18

  
VERTICAL POSITION  
E431 / E611

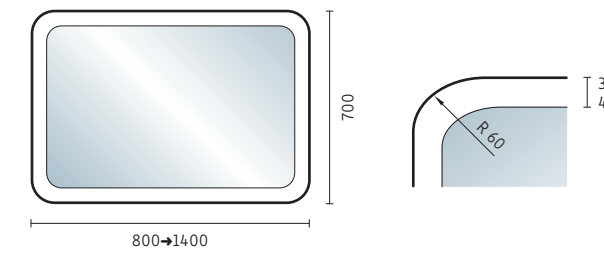

TRANSPARENT PERIMETER.

**bright**

Ref.:	E440		E620	
Measure. up to	Perimeter 3 transparent	Perimeter 3 transp.+light	Perimeter 4 sandblasted	Perimeter 4 sand.+light
80 x 70	356,66	757,90	347,37	737,47
90 x 70	384,52	782,05	373,38	761,62
100 x 70	401,24	808,06	390,10	783,91
120 x 70	460,68	850,78	445,82	824,77
140 x 70	505,27	908,37	490,41	882,36

  
+£111,46

  
+£167,18

  
VERTICAL POSITION  
E441 / E621

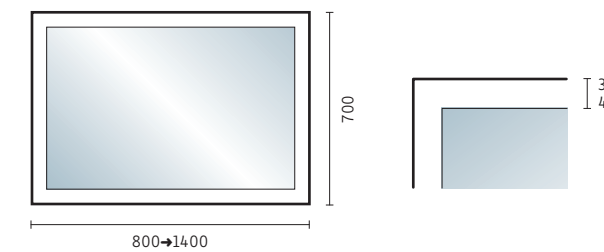

TRANSPARENT PERIMETER.



COLLECTION  
**SAND**



**sandblasted top**

Ref.:	Width	Height	Sandblasted top
E390	60	70	614,87
	70	70	655,73
	80	70	678,02
	90	70	717,03
	100	70	750,47
	120	70	886,08
	140	70	995,67

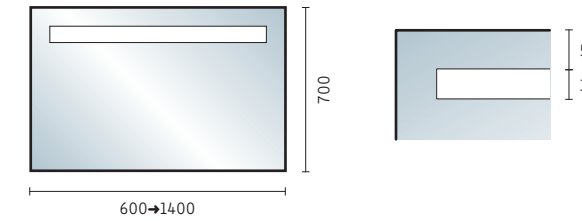

**sandblasted vertical**

Ref.:	Width	Height	Sandblasted vertical
E400	60	70	737,47
	70	70	769,05
	80	70	813,63
	90	70	847,07
	100	70	887,93
	120	70	923,23
	140	70	1.014,25

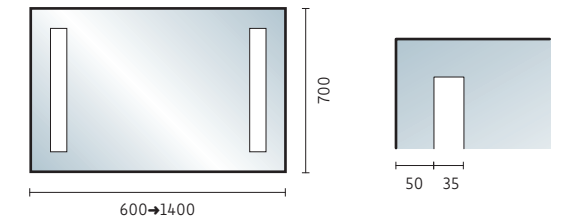

**sandblasted frame 15**

Ref.:	Width	Height	Perimeter 15
E410	60	70	704,03
	70	70	728,18
	80	70	744,90
	90	70	774,62
	100	70	819,20
	120	70	856,35
	140	70	926,94

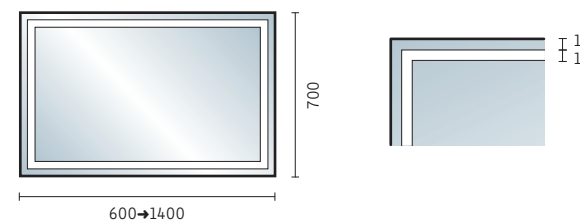

**sandblasted frame 35**

Ref.:	Width	Height	Perimeter 35
E820	60	70	739,32
	70	70	765,33
	80	70	782,05
	90	70	813,63
	100	70	860,07
	120	70	899,08
	140	70	973,38

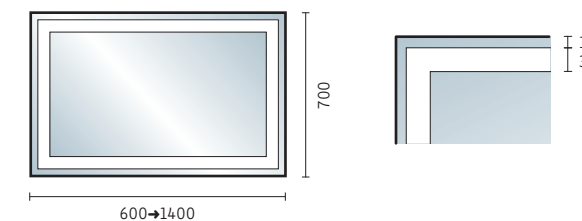

VERTICAL POSITION E411



VERTICAL POSITION E821





COLLECTION  
**COMBI**



**horizontal band**

Ref.:	Width up to	Height up to	FANTASY	ARLUX	SELECT LAC. MATT FENIX	WOOD
E02	60	70	230,34	274,92	373,38	475,55
	70	70	258,21	317,65	445,82	525,70
	80	70	286,07	352,94	497,84	566,57
	90	70	317,65	391,95	546,13	616,72
	100	70	336,23	419,82	600,00	678,02
	120	70	377,09	475,55	685,45	780,19
	140	70	453,25	568,43	806,20	928,80

- On 2 cm board.
- Unless otherwise stated, the band is 8.5 cm wide.



**centred glass**

Ref.:	Width up to	Height up to	FANTASY	ARLUX	SELECT LAC. MATT FENIX	WOOD
E010	60	70	230,34	274,92	373,38	475,55
	70	70	258,21	317,65	445,82	525,70
	80	70	286,07	352,94	497,84	566,57
	90	70	317,65	391,95	546,13	616,72
	100	70	336,23	419,82	600,00	678,02
	120	70	377,09	475,55	685,45	780,19
	140	70	453,25	568,43	806,20	928,80

- On 2 cm board.
- Unless otherwise stated, frame 3 cm wide.

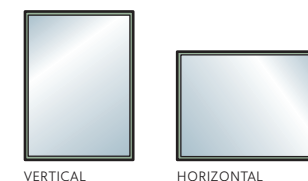

**displaced band**

Ref.:	Width up to	Height up to	FANTASY	ARLUX	SELECT LAC. MATT FENIX	WOOD
E050	60	70	230,34	274,92	373,38	475,55
	70	70	258,21	317,65	445,82	525,70
	80	70	286,07	352,94	497,84	566,57
	90	70	317,65	391,95	546,13	616,72
	100	70	336,23	419,82	600,00	678,02
	120	70	377,09	475,55	685,45	780,19
	140	70	453,25	568,43	806,20	928,80

- On 2 cm board.
- Unless otherwise stated, the band is 8.5 cm wide.
- Indicate side of displacement.

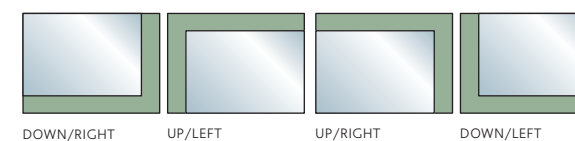

COLLECTION  
**LACK**

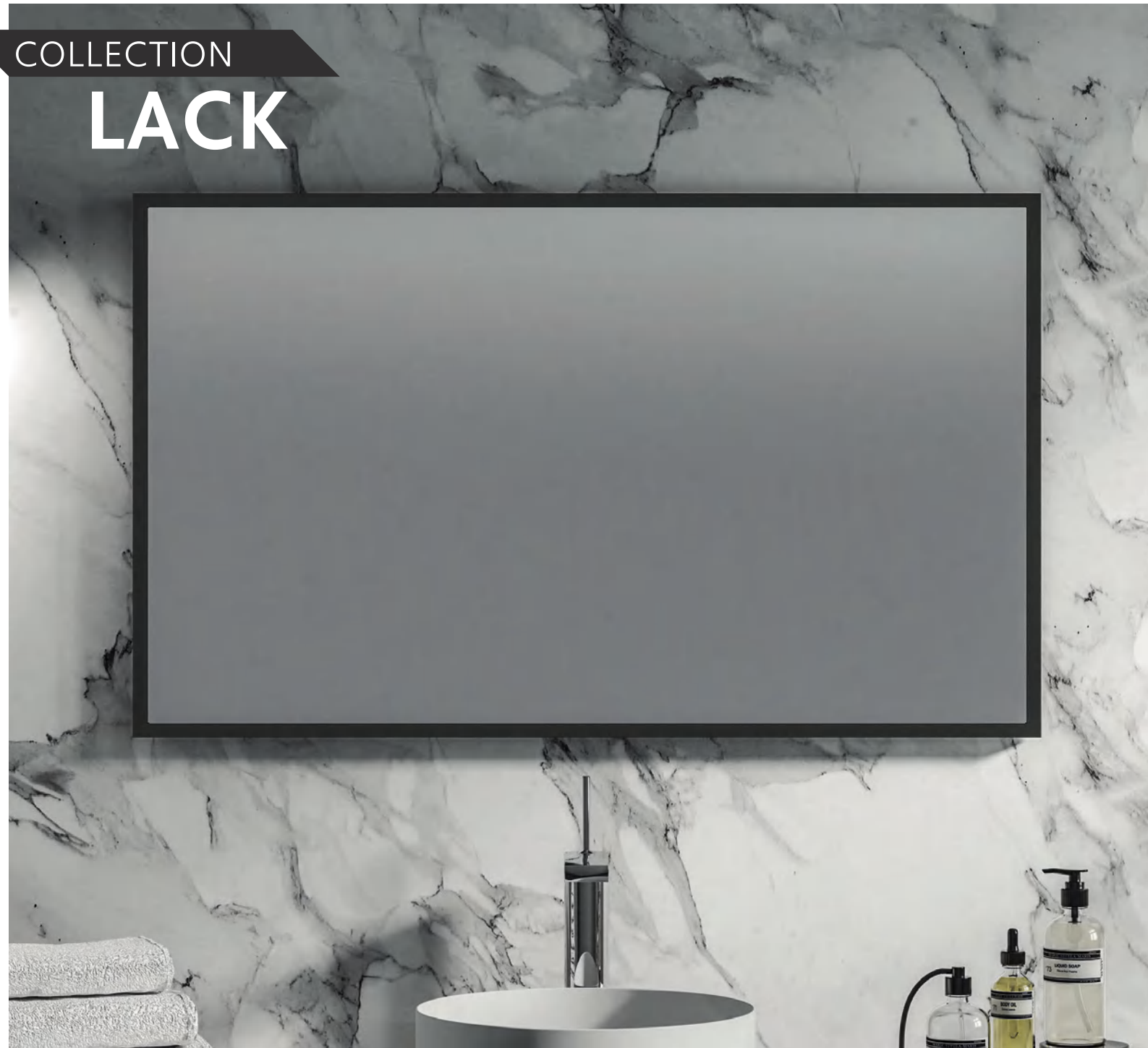

**flush straight glass**

Ref.:	Width up to	Height up to	Matt Select Lacquer
E130	70	70	508,98
	80	70	566,57
	90	70	616,72
	100	70	681,74
	120	70	782,05
	140	70	921,37

- Flush to 2 cm board.
- Unless otherwise stated, frame 1.2 cm wide.

**flush circular glass**

Ref.:	Diameter	Matt Select Lacquer
E12	Ø80	724,46
	Ø90	783,91
	Ø100	839,64

- Flush to 2 cm board.
- Unless otherwise stated, frame 5 cm wide.



COLLECTION  
**CLASSIC**



+10%<sup>x10</sup>

+£111,46

+£120,74

VERTICAL POSITION  
**E451**

**smooth glass**  
TOTAL AMBIENT LIGHT

Ref.:	Width up to	Height up to	Ambient light total
<b>E450</b>	70	70	559,14
	80	70	583,29
	90	70	620,44
	100	70	666,88
	120	70	718,89
140	70	808,06	

• Optional built-in magnification mirror is supplied Ø18 cm to the right, height centred and 10 cm from the edge.

ONLY ONE OPTION

+£139,32

+£260,06

+£501,55

+£167,18

+10%<sup>x10</sup>

+£111,46

+£120,74

VERTICAL POSITION  
**E671**

**smooth glass**  
TOP/BOTTOM AMBIENT LIGHT

Ref.:	Width up to	Height up to	Ambient light top and bottom
<b>E670</b>	70	70	507,12
	80	70	542,42
	90	70	566,57
	100	70	601,86
	120	70	646,44
140	70	696,60	

• Optional built-in magnification mirror is supplied Ø18 cm to the right, height centred and 10 cm from the edge.

ONLY ONE OPTION

+£139,32

+£260,06

+£501,55

+£167,18

+10%<sup>x10</sup>

+£111,46

VERTICAL POSITION  
**E071**

**smooth glass**  
RECESSED BACK

Ref.:	Width up to	Height up to	Recessed back
<b>E070</b>	70	70	261,92
	80	70	284,21
	90	70	315,79
	100	70	339,94
	120	70	380,81
140	70	449,54	

• Back in charcoal finish and aluminium-coloured edge, recessed 3 cm.  
• Built-in magnification mirror option is supplied Ø18 cm to the right, height centred and 10 cm from the edge.

ONLY ONE OPTION

+£139,32

+£260,06

+£501,55

+10%<sup>x10</sup>

+£111,46

VERTICAL POSITION  
**E031**

**smooth glass**  
WITH BACK

Ref.:	Width up to	Height up to	With back
<b>E030</b>	70	70	256,35
	80	70	276,78
	90	70	308,36
	100	70	332,51
	120	70	373,38
140	70	436,54	

• Back in charcoal finish and aluminium-coloured edge.  
• Built-in magnification mirror option is supplied Ø18 cm to the right, height centred and 10 cm from the edge.

ONLY ONE OPTION

+£139,32

+£260,06

+£501,55

+10%<sup>x10</sup>

+£111,46

VERTICAL POSITION  
**E041**

**smooth glass**  
WITHOUT BACK

Ref.:	Width up to	Height up to	Without back
<b>E040</b>	70	70	228,48
	80	70	248,92
	90	70	263,78
	100	70	276,78
	120	70	315,79

• Built-in magnification mirror option is supplied Ø18 cm to the right, height centred and 10 cm from the edge.

ONLY ONE OPTION

+£139,32

+£260,06





+10% x10



+£111,46



+£120,74



VERTICAL POSITION  
E461

glass 0.5 bevel

TOTAL AMBIENT LIGHT

Ref.:	Width up to	Height up to	Ambient light total
E460	70	70	596,29
	80	70	627,87
	90	70	666,88
	100	70	698,46
	120	70	757,90
	140	70	852,64

• Built-in magnification mirror option is supplied Ø18 cm to the right, height centred and 10 cm from the edge.

ONLY ONE OPTION



+£139,32



+£260,06

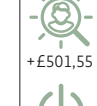

+£501,55



+£167,18

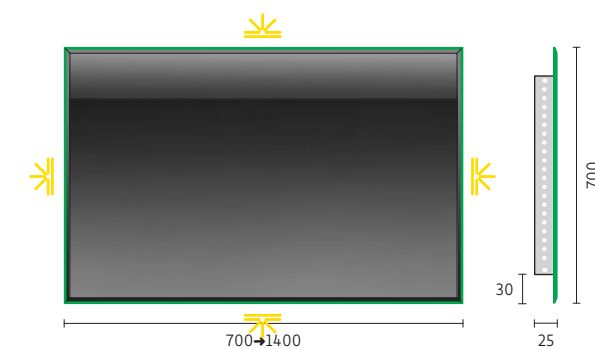

+10% x10



+£111,46



+£120,74



VERTICAL POSITION  
E681

glass 0.5 bevel

TOP/BOTTOM AMBIENT LIGHT

Ref.:	Width up to	Height up to	Ambient light top and bottom
E680	70	70	577,71
	80	70	609,29
	90	70	646,44
	100	70	678,02
	120	70	735,61
	140	70	826,63

• Built-in magnification mirror option is supplied Ø18 cm to the right, height centred and 10 cm from the edge.

ONLY ONE OPTION



+£139,32



+£260,06

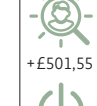

+£501,55



+£167,18

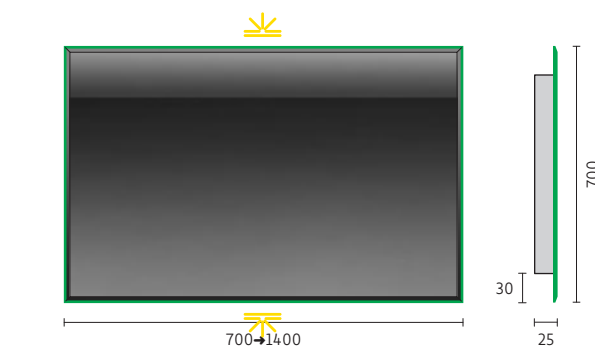

+10% x10



+£111,46



VERTICAL POSITION  
E150

glass 0.5 bevel

WITH BACK

Ref.:	Width up to	Height up to	With back
E150	70	70	287,93
	80	70	312,08
	90	70	345,51
	100	70	373,38
	120	70	416,10
	140	70	484,83

• Back in Elegance finish and aluminium-coloured edge.  
• Built-in magnification mirror option is supplied Ø18 cm to the right, height centred and 10 cm from the edge.

ONLY ONE OPTION



+£139,32



+£260,06



+£501,55

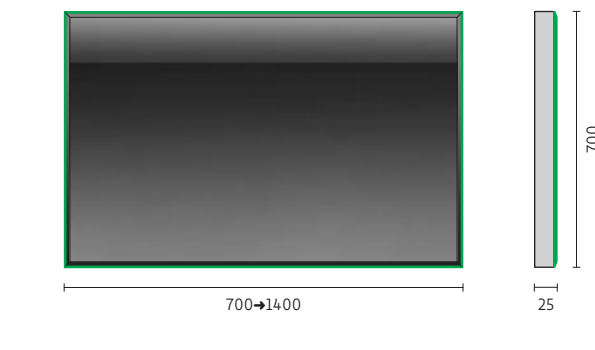

+10% x10



+£111,46



VERTICAL POSITION  
E140

glass 0.5 bevel

WITHOUT BACK

Ref.:	Width up to	Height up to	Without back
E140	70	70	256,35
	80	70	276,78
	90	70	299,07
	100	70	313,93
	120	70	354,80

• Built-in magnification mirror option is supplied Ø18 cm to the right, height centred and 10 cm from the edge.

ONLY ONE OPTION



+£139,32



+£260,06

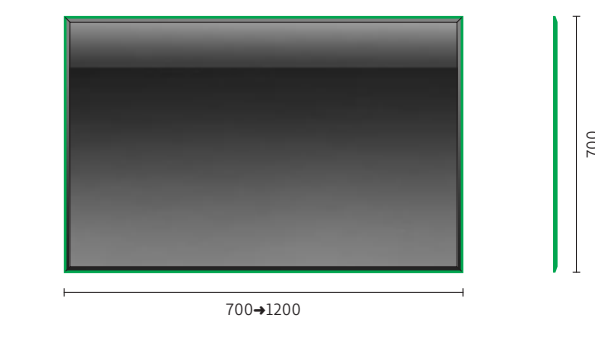



+10%<sup>x10</sup>

+£111,46

+£120,74

### bevel 3 glass

**TOTAL AMBIENT LIGHT**

Ref.:	Width up to	Height up to	Ambient light total
E470	70	70	626,01
	80	70	665,02
	90	70	702,17
	100	70	739,32
	120	70	815,49
	140	70	895,36

• Built-in magnification mirror option is supplied Ø18 cm to the right, height centred and 10 cm from the edge.

ONLY ONE OPTION

+£139,32

+£260,06

+£501,55

+£167,18

+10%<sup>x10</sup>

+£111,46

+£120,74

### bevel 3 glass

**TOP/BOTTOM AMBIENT LIGHT**

Ref.:	Width up to	Height up to	Ambient light top and bottom
E690	70	70	607,44
	80	70	644,59
	90	70	681,74
	100	70	717,03
	120	70	791,34
	140	70	869,36

• Built-in magnification mirror option is supplied Ø18 cm to the right, height centred and 10 cm from the edge.

ONLY ONE OPTION

+£139,32

+£260,06

+£501,55

+£167,18

+10%<sup>x10</sup>

+£111,46

### glass 3 bevel

**WITH BACK**

Ref.:	Width up to	Height up to	With back
E170	70	70	325,08
	80	70	352,94
	90	70	388,24
	100	70	417,96
	120	70	468,12
	140	70	536,85

• Back in Elegance finish and aluminium-coloured edge.

• Built-in magnification mirror option is supplied Ø18 cm to the right, height centred and 10 cm from the edge.

ONLY ONE OPTION

+£139,32

+£260,06

+£501,55

+10%<sup>x10</sup>

+£111,46

VERTICAL POSITION E161

### glass 3 bevel

**WITHOUT BACK**

Ref.:	Width up to	Height up to	Without back
E160	70	70	295,36
	80	70	317,65
	90	70	336,23
	100	70	373,38
	120	70	412,39

• Built-in magnification mirror option is supplied Ø18 cm to the right, height centred and 10 cm from the edge.

ONLY ONE OPTION

+£139,32

+£260,06



COLLECTION  
**DECO**



**decorative mirror**

-  +£111,46
-  +£269,35
-  +£139,32

Ref.:	Width up to	Height up to	Depth	FANTASY	ARLUX	SELECT.LAC.MATT FENIX	WOOD
A20	80	70	13	362,23	462,54	572,14	676,17
	90	70	13	397,53	497,84	607,44	709,60
	100	70	13	436,54	536,85	640,87	741,18
	120	70	13	527,56	607,44	720,75	822,92

• Visible top adjustment.



**decorative mirror right side**

-  +£111,46
-  +£269,35
-  +£139,32
-  SIDE LEFT  
A211

Ref.:	Width up to	Height up to	Depth	FANTASY	ARLUX	SELECT.LAC.MATT FENIX	WOOD
A210	80	70	13	436,54	547,99	681,74	802,48
	100	70	13	523,84	644,59	763,47	887,93
	120	70	13	629,73	730,04	863,78	986,39
	140	70	13	750,47	871,21	1.034,68	1.179,58

• Visible top adjustment.

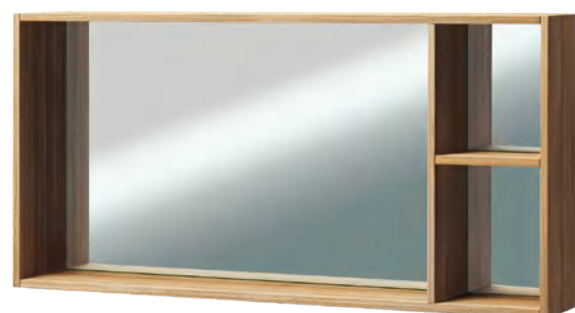

**decorative mirror central**

-  +£111,46
-  +£269,35

Ref.:	Width up to	Height up to	Depth	FANTASY	ARLUX	SELECT.LAC.MATT FENIX	WOOD
A22	120	70	13	691,03	804,34	952,95	1.086,70
	140	70	13	824,77	960,38	1.140,57	1.296,60
	160	70	13	952,95	1.103,41	1.304,04	1.450,79

- Visible top adjustment.
- Optional antimist device, indicate position.



**flat ambient light**

-  +£111,46
-  VERTICAL POSITION  
A231

Ref.:	Width up to	Height up to	Depth	FANTASY	ARLUX	SELECT.LAC.MATT FENIX	WOOD
A230	80	70	13	750,47	850,78	967,81	1.069,98
	90	70	13	824,77	925,08	1.045,83	1.146,14
	100	70	13	912,08	1.012,39	1.125,71	1.224,16
	120	70	13	1.088,55	1.170,29	1.294,75	1.389,48

• Visible top regulation. Perimeter 3 cm.



**loft vertical ambient light**

-  +£111,46

Ref.:	Width up to	Height up to	Depth	FANTASY	ARLUX	SELECT.LAC.MATT FENIX	WOOD
A24	60	90	13	765,33	848,92	954,81	1.075,55
	80	90	13	865,64	969,67	1.088,55	1.196,29

• Fixed cube without mirror 15 cm. Visible top adjustment.



**loft horizontal ambient light**

-  +£111,46

Ref.:	Width up to	Height up to	Depth	FANTASY	ARLUX	SELECT.LAC.MATT FENIX	WOOD
A34	80	70	13	698,46	800,63	915,80	1.017,96
	90	70	13	774,62	873,07	993,82	1.095,98
	100	70	13	861,93	962,24	1.073,69	1.170,29
	120	70	13	1.038,40	1.120,13	1.242,73	1.337,47

• Fixed cube without mirror 15 cm. Visible top regulation.



COLLECTION

# DOUBLE MIRRORED CABINETS



+£269,35

+£53,87

+£92,88

+£126,32

**STONE**

### 1 door

Ref.:	Width up to	Height up to	Depth	RRP
A50	40	70	15→19	<b>873,07</b>
	50	70	15→19	<b>952,95</b>

- Indicate side.
- Supplied with straight door and recessed base.
- The bottom includes the thickness of the door.

+£269,35

+£53,87

+£92,88

+£126,32

**STONE**

### 2 doors

Ref.:	Width up to	Height up to	Depth	RRP
A53	70	70	15→19	<b>1.320,75</b>
	80	70	15→19	<b>1.447,07</b>
	90	70	15→19	<b>1.538,09</b>

- Supplied with straight doors and recessed base.
- The bottom includes the thickness of the door.

+£269,35

+£53,87

+£92,88

+£126,32

**STONE**

### 2 asymmetrical doors

Ref.:	Width up to	Height up to	Depth	RRP
A51	70	70	15→19	<b>1.320,75</b>
	80	70	15→19	<b>1.447,07</b>
	90	70	15→19	<b>1.538,09</b>

- Supplied with straight doors and recessed base.
- The bottom includes the thickness of the door.

70

40 30

80

50 30

90

55 35

+£269,35

+£53,87

+£92,88

+£126,32

**STONE**

### 3 doors

Ref.:	Width up to	Height up to	Depth	RRP
A54	80	70	15→19	<b>1.647,69</b>
	100	70	15→19	<b>1.827,88</b>
	120	70	15→19	<b>1.946,76</b>

- Supplied with straight doors and recessed base.
- The bottom includes the thickness of the door.

+£269,35

+£53,87

+£92,88

+£126,32

**STONE**

### 3 asymmetrical doors

Ref.:	Width up to	Height up to	Depth	RRP
A52	80	70	15→19	<b>1.647,69</b>
	100	70	15→19	<b>1.827,88</b>
	120	70	15→19	<b>1.946,76</b>

- Supplied with straight doors and recessed base.
- The bottom includes the thickness of the door.

80

22 36 22

100

27 46 27

120

35 50 35



COLLECTION

# MIRRORED DOOR CABINETS



IMAGE REPRESENTED WITH OPTIONAL GLASS SHELVES AND INTERIOR LED LIGHTING.

-  +£269,35
-  +£53,87
-  +£92,88
-  +£126,32

## 1 door

Ref.:	Width up to	Height up to	Depth	FANTASY	ARLUX	SELECT.LAC. MATT FENIX	WOOD
A41	40	70	15→19	356,66	442,11	492,26	568,43
	50	70	15→19	388,24	484,83	544,28	626,01

- Indicate side.
- Supplied with straight door and recessed base.
- The bottom includes the thickness of the door.



## 2 doors

Ref.:	Width up to	Height up to	Depth	FANTASY	ARLUX	SELECT.LAC. MATT FENIX	WOOD
A42	70	70	15→19	505,27	631,58	707,75	813,63
	80	70	15→19	555,42	694,74	778,33	889,79
	90	70	15→19	613,01	765,33	863,78	984,53

- Supplied with straight doors and recessed base.
- The bottom includes the thickness of the door.



## 2 asymmetrical doors

Ref.:	Width up to	Height up to	Depth	FANTASY	ARLUX	SELECT.LAC. MATT FENIX	WOOD
A15	70	70	15→19	505,27	631,58	707,75	813,63
	80	70	15→19	555,42	694,74	778,33	889,79
	90	70	15→19	613,01	765,33	863,78	984,53

- Supplied with straight doors and recessed base.
- The bottom includes the thickness of the door.

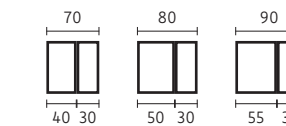

## 3 asymmetrical doors

Ref.:	Width up to	Height up to	Depth	FANTASY	ARLUX	SELECT.LAC. MATT FENIX	WOOD
A17	80	70	15→19	678,02	750,47	815,49	947,38
	100	70	15→19	744,90	809,91	902,79	1.032,83
	120	70	15→19	787,62	867,50	973,38	1.161,00

- Supplied with straight doors and recessed base.
- The bottom includes the thickness of the door.

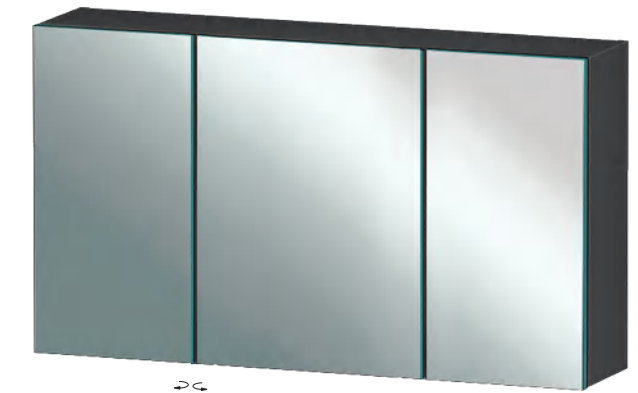
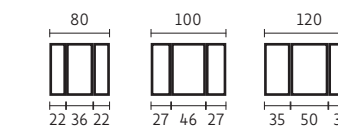

## 3 triptych doors

Ref.:	Width up to	Height up to	Depth	FANTASY	ARLUX	SELECT.LAC. MATT FENIX	WOOD
A46	80	70	15→19	700,32	772,76	830,35	1.004,96
	100	70	15→19	769,05	830,35	925,08	1.108,99
	120	70	15→19	811,77	891,65	991,96	1.187,01

- Supplied with straight doors and recessed base.
- The bottom includes the thickness of the door.

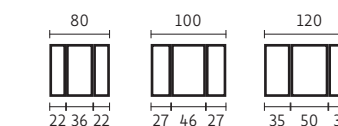



# LIGHTING



## tube durian®

Ref.:	Height	Diameter	Durian*	Black	Gold
9011000001XX	25	Ø7	248,92	438,39	482,98

• 1.5-metre white cable.

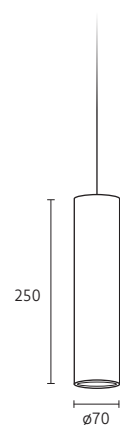

## ceiling metallic

Ref.:	Height	Diameter	Durian*	Black	Gold
Q20	25	Ø6	287,93	287,93	316,72

• Semi-polished steel.  
• 1-metre black cable.

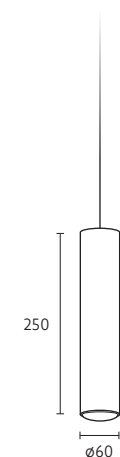

## ebro

Ref.:	Width	Depth	W	°K	Lumen	Chrome
Q10	28	11	6	5700°	457	178,33
	49	11	8	5700°	568	213,62
	49	11	8	4000°	568	213,62
	80	11	10	5700°	791	286,07
	100	11	15	5700°	1265	343,66
	120	11	18	5700°	1532	388,24

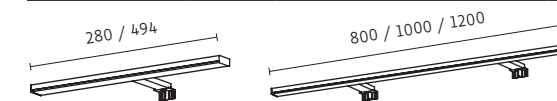

## ebro black

Ref.:	Width	Depth	W	°K	Lumen	Black
Q101	30	11	7	5700°	457	213,62
	50	11	9	5700°	568	250,78

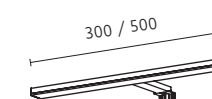

## narcea

Ref.:	Width	Depth	W	°K	Lumen	RRP
Q06	30	11	7	5700°	599	126,32
	50	11	9	5700°	648	165,33
	80	11	12	5700°	1169	232,20



## bidasoa

Ref.:	Width	Depth	W	°K	Lumen	RRP
Q07	30	11	7	4000°	637	157,90
	50	11	9	4000°	919	183,90
	80	11	10	4000°	1052	256,35

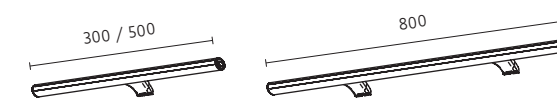

08.

# COUNTERTOPS & WASHBASINS

PIVSTONE® ..... p.130

DURIAN® ..... p.136

CERAMIC ..... p.162





  
**PIVSTONE**

**PIUTECH TECHNOLOGY**

A TRANSPARENT COATING IS APPLIED TO THE PIVSTONE® COUNTERTOPS TO SEAL THE PORES ON THE SURFACE, GIVING IT GREAT SOLIDITY AND RESISTANCE AGAINST EXTERNAL AGENTS WITHOUT ALTERING THE PROPERTIES, ELEGANCE AND STYLE OF THE NATURAL STONE.

STRICT QUALITY CONTROLS VERIFY AND CHECK EVEN THE TINIEST DETAILS OF THE PRODUCTION PROCESS.

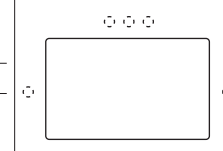
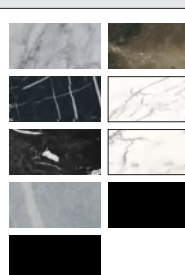

**COUNTERTOP CONFIGURATION**

1 MEASUREMENTS	2 WASHBASIN LOCATION	3 TAP POSITION	4 BASIN MEASUREMENT	5 TOP PANEL THICKNESS	6 FINISHES
M1 Depth	M3 Displacement		1 45x27 2 60x27 9 To measure maximum 1 metre (check price)	1,2 cm. PORCELAIN	
M2 Width				2 cm. PIUTECH MARBLE	
M4 Back top				4→8 cm. PORCELAIN PIUTECH MARBLE	
M5 Waste distance				8,1→18 cm. PORCELAIN PIUTECH MARBLE	
M6 Front top					
G1 Side wall angle					
G2 Side wall angle					

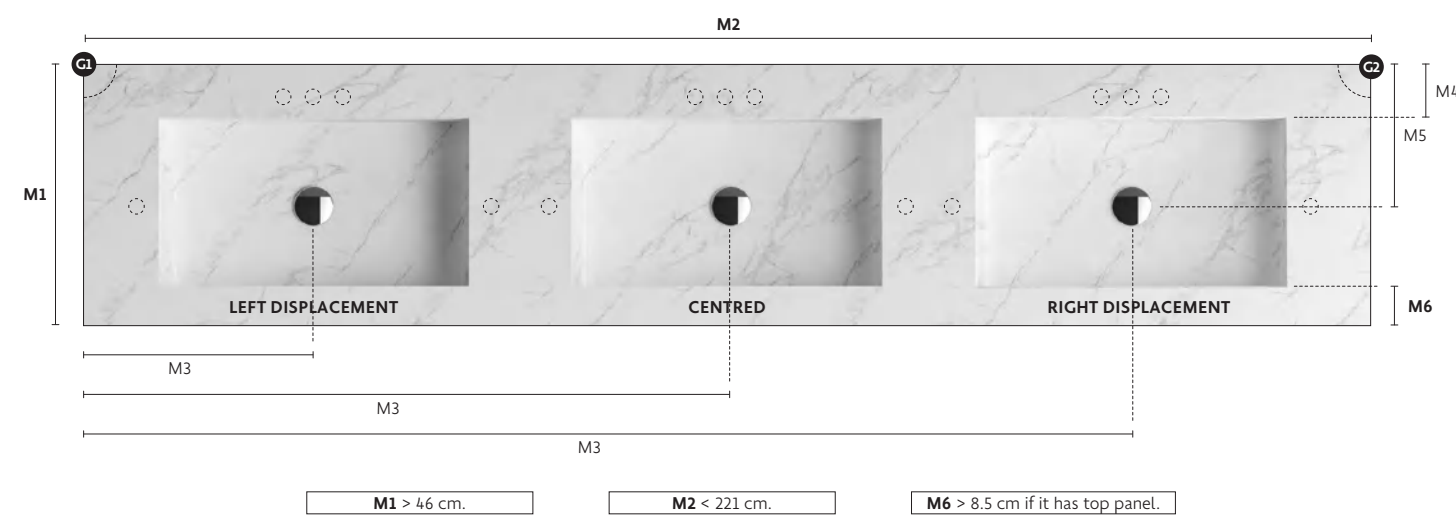

• For countertops over 90 cm on unit, it is necessary to install reinforcement brackets.

**FINISHES**

piutech marble  
THICKNESS 20→180

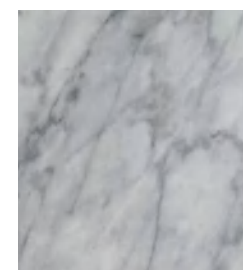

M01 CARRARA

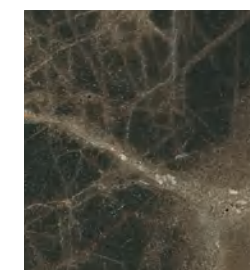

M04 DARK EMPERADOR

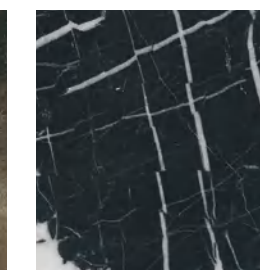

M05 MARQUINA BLACK

piutech compact  
THICKNESS 20→180



C01 CALACATTA



C04 MARQUINA BLACK

porcelain  
THICKNESS 12→180

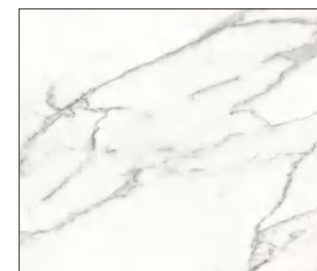

P01 CALACATTA

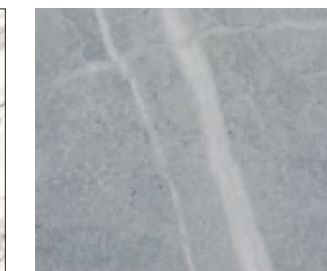

P02 ZAHA STONE



P04 MARQUINA BLACK



P05 BASALT BLACK



More information and assembly instructions.



DARK EMPERADOR



ZAHA STONE

## PIVSTONE MYKONOS

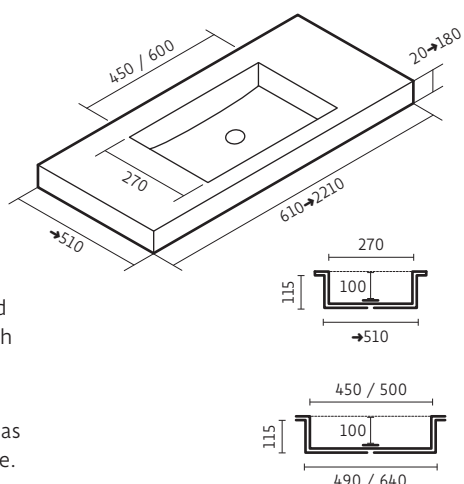

Piutech Marble allows the washbasin and countertop to form a seamless finish with no visible joints.

A rounded drop towards the click-clack waste valve at the bottom of the basin has been designed for perfect water drainage.

### PIUTECH MARBLE

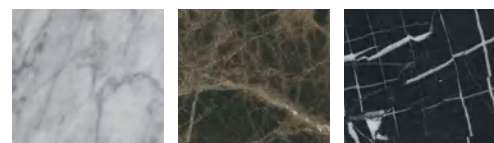

M01 CARRARA M04 DARK EMPERADOR M05 MARQUINA BLACK

### PIUTECH COMPACT

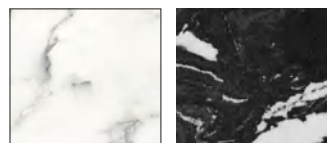

C01 CALACATTA C04 MARQUINA BLACK

Reference	Width up to
101SFM061AAA	61
101SFM071AAA	71
101SFM081AAA	81
101SFM091AAA	91
101SFM101AAA	101
101SFM111AAA	111
101SFM121AAA	121
101SFM131AAA	131
101SFM141AAA	141
101SFM151AAA	151
101SFM161AAA	161
101SFM171AAA	171
101SFM181AAA	181
101SFM191AAA	191
101SFM201AAA	201
101SFM211AAA	211
101SFM221AAA	221

• Overflow not available.

### MARBLE/COMPACT

Thickness 2	Thickness 4-8	Thickness 8.1-18
1.346,76	1.722,00	1.991,35
1.434,07	1.850,17	2.132,52
1.521,37	1.980,20	2.275,56
1.608,68	2.108,38	2.416,74
1.695,99	2.238,41	2.557,92
1.783,30	2.368,44	2.700,95
1.870,60	2.496,61	2.842,13
1.957,91	2.626,65	2.983,31
2.045,22	2.754,82	3.126,34
2.132,52	2.884,85	3.267,52
2.219,83	3.013,03	3.408,70
2.307,14	3.143,06	3.551,73
2.394,45	3.273,09	3.692,91
2.481,75	3.401,27	3.834,09
2.569,06	3.531,30	3.977,12
2.656,37	3.659,47	4.118,30
2.743,68	3.789,50	4.261,33

## PIVSTONE THAIS

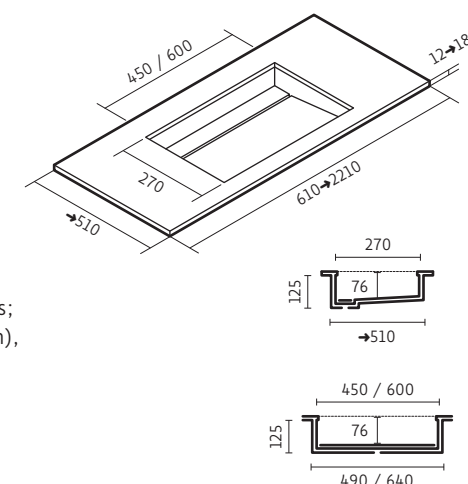

Porcelain materials have unique qualities; wide variety of thicknesses (from 1.2 cm), homogeneous grain and no porosity.

### PORCELAIN



P01 CALACATTA P02 ZAHA STONE P04 MARQUINA BLACK P05 BASALT BLACK

Reference	Width up to
151SFM061AAA	61
151SFM071AAA	71
151SFM081AAA	81
151SFM091AAA	91
151SFM101AAA	101
151SFM111AAA	111
151SFM121AAA	121
151SFM131AAA	131
151SFM141AAA	141
151SFM151AAA	151
151SFM161AAA	161
151SFM171AAA	171
151SFM181AAA	181
151SFM191AAA	191
151SFM201AAA	201
151SFM211AAA	211
151SFM221AAA	221

• Overflow not available.

### PORCELAIN

Thickness 1.2	Thickness 4-8	Thickness 8.1-18
1.879,89	2.411,16	2.856,99
2.009,92	2.595,07	3.063,18
2.138,10	2.778,97	3.267,52
2.268,13	2.962,87	3.471,85
2.398,16	3.146,77	3.676,19
2.526,34	3.330,68	3.882,38
2.656,37	3.514,58	4.086,72
2.784,54	3.698,48	4.291,06
2.914,57	3.884,24	4.495,39
3.042,75	4.068,14	4.701,59
3.172,78	4.252,05	4.905,92
3.300,96	4.435,95	5.110,26
3.430,99	4.619,85	5.314,59
3.559,16	4.803,75	5.520,79
3.689,19	4.987,66	5.725,12
3.819,23	5.171,56	5.929,46
4.131,30	5.355,46	6.133,80





MARQUINA BLACK

## PIVSTONE COUNTERTOPS W/O WASHB.



PIVSTONE® countertops can be easily combined with any countertop washbasin. The technical data sheet of that washbasin must be enclosed for the precise machining of siphons and taps.

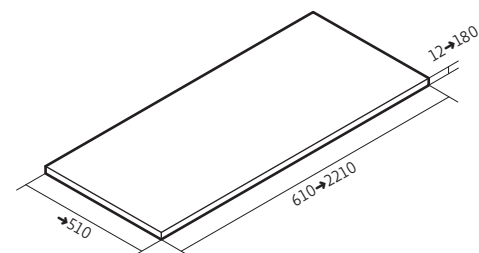

Reference	Width up to
200SFM061AAA	61
200SFM071AAA	71
200SFM081AAA	81
200SFM091AAA	91
200SFM101AAA	101
200SFM111AAA	111
200SFM121AAA	121
200SFM131AAA	131
200SFM141AAA	141
200SFM151AAA	151
200SFM161AAA	161
200SFM171AAA	171
200SFM181AAA	181
200SFM191AAA	191
200SFM201AAA	201
200SFM211AAA	211
200SFM221AAA	221

### MARBLE/COMPACT

Thickness 2	Thickness 4→8	Thickness 8.1→18
533,13	945,52	1.216,73
620,44	1.081,12	1.363,48
707,75	1.216,73	1.512,09
795,05	1.352,33	1.660,69
882,36	1.487,94	1.809,30
969,67	1.623,54	1.956,05
1.056,97	1.759,15	2.104,66
1.144,28	1.894,75	2.253,27
1.231,59	2.035,93	2.401,88
1.318,90	2.165,96	2.548,63
1.406,20	2.301,57	2.697,24
1.493,51	2.437,17	2.845,84
1.580,82	2.572,78	2.994,45
1.668,12	2.708,38	3.143,06
1.755,43	2.843,99	3.289,81
1.842,74	2.979,59	3.438,42
1.930,05	3.115,20	3.587,03

### PORCELAIN

Thickness 1.2	Thickness 4→8	Thickness 8.1→18
787,62	1.318,90	1.764,72
917,65	1.502,80	1.969,06
1.045,83	1.686,70	2.175,25
1.175,86	1.870,60	2.379,59
1.304,04	2.054,51	2.583,92
1.434,07	2.238,41	2.790,12
1.562,24	2.422,31	2.994,45
1.692,27	2.606,21	3.198,79
1.822,31	2.790,12	3.403,12
1.950,48	2.974,02	3.609,32
2.080,51	3.159,78	3.813,65
2.208,69	3.343,68	4.017,99
2.338,72	3.527,58	4.222,32
2.466,89	3.692,91	4.426,66
2.596,92	3.895,39	4.632,85
2.725,10	4.079,29	4.837,19
2.855,13	4.263,19	5.041,53

• Overflow not available. Countertop hole depth other manufacturers +£154,80.

## ACCESSORIES

### straight backsplash

Ref.:	Height up to	Marble /Compact	Porcel.
20501X100AAA	8	143,03	154,18
20501X100AAA	30	427,25	538,70

- Minimum chargeable 1 metre.
- Price per linear metre.

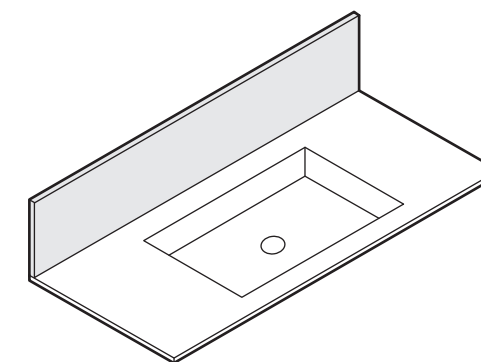

### towel holders

Ref.:	Model	Width	RRP
98002M050101	Superior	30→50	176,47
98003M050101	Front	30→50	176,47

- Upper towel rail minimum overhang 8 cm (3+4+1).
- The front towel rail is supplied height centred.

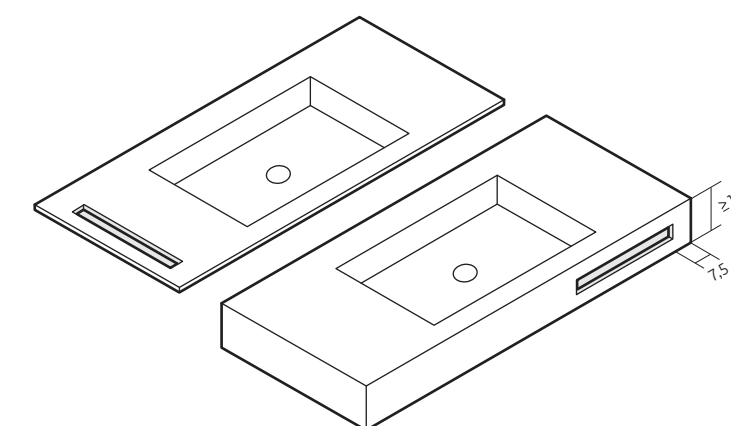

### invisible bracket

Ref.:	Units	Depth	Stainless steel
P160NN026	2	26	148,61
P160NN041	2	41	176,47
P170NN026	3	26	232,20
P170NN041	3	41	306,50

- For countertops over 90 cm on unit, it is necessary to install reinforcement brackets.

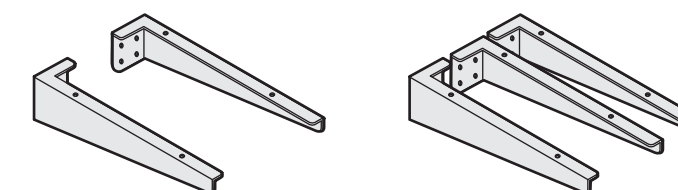

### second washbasin

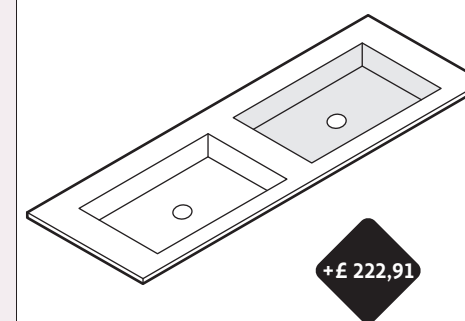

### second hole

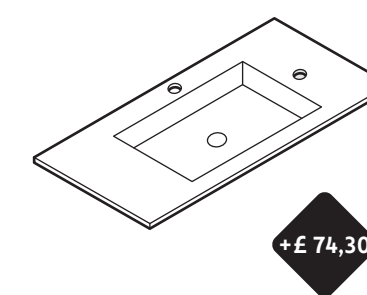

### straight cuts

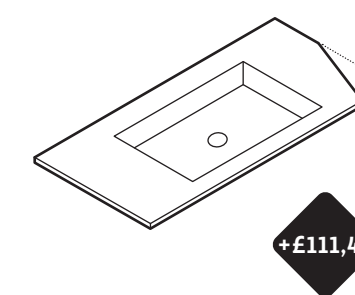

# durian®

Durian® is a registered trademark of Solid Surface manufactured by KYRYA® group, which holds all the quality certifications.

The main component is a mineral (Alumina Trihydrate) which when mixed with a low percentage of resins makes our product injectable in moulds to achieve the desired shapes. It comes in its natural neutral white colour, is pleasant to the touch, similar to compact mineral, has high hardness, high impact resistance and allows the construction of spaces with no visible joints, as it is homogeneous and solid throughout its thickness.

Durian® represents the personality, elegance and creativity of materials that offer the possibility of any design style.



HIGH QUALITY



MOULDABLE



HYGIENIC



ENVIRONMENTALLY FRIENDLY



REPAIRABLE



CLEAN & DURABLE

## MEASUREMENTS NEEDED TO CONFIGURE A WORKTOP

For the correct configuration of the made-to-measure Durian® countertop, the dimensions, thickness and location of the washbasin and taps are required. If not indicated, it will be supplied by default.

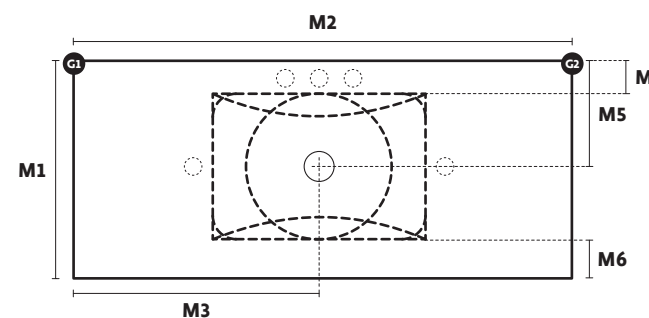

ESSENTIALS	M1	Countertop depth (overhangs included).
	M2	Countertop length (overhangs included).
	M3	Distance from wall to waste axis (only required for displaced basins).
OPTIONAL	M4	Distance from wall to start of basin (required for wall-mounted taps).
	M5	Location of the basin in depth.
	M6	Distance from basin to outer front edge.
	G1	Left angle other than 90°.
	G2	Right angle other than 90°.

## COUNTERTOP THICKNESSES

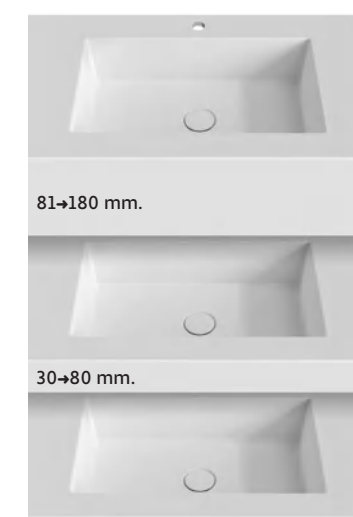

Durian® allows us to customise the thickness of the countertop, starting with a 12 mm base plate and increasing the perimeter to the required thickness.

## QUALITY CERTIFICATE



Durian® in collaboration with the International Technological Institute AIDIMME, recognised by the Ministry of Science and Innovation, has certified that our products meet all the requirements that guarantee its commercialisation with the necessary technical demands for their use.

# durian BARI

# durian BARI



## bari with perimeter

/60 - 90 cm./

Reference	Width up to	Depth	Height	Washb. 60	Washb. 90
180 OZO 080 2PO	81	36→53	12	815,49	-
180 OZO 090 2PO	91	36→53	12	910,22	-
180 OZO 100 2PO	101	36→53	12	967,81	1.064,40
180 OZO 110 2PO	111	36→53	12	1.051,40	1.148,00
180 OZO 120 2PO	121	36→53	12	1.134,99	1.233,45
180 OZO 140 2PO	141	36→53	12	1.597,54	1.694,13
180 OZO 160 2PO	161	36→53	12	1.796,30	1.894,75
180 OZO 180 2PO	181	36→53	12	2.065,65	2.162,25

- Z=6 Washbasin 60 / Z=9 Washbasin 90 / P=1 Washbasin left / P=2 Washbasin right.
- With rear tap minimum depth 45 cm.
- Waste not included.

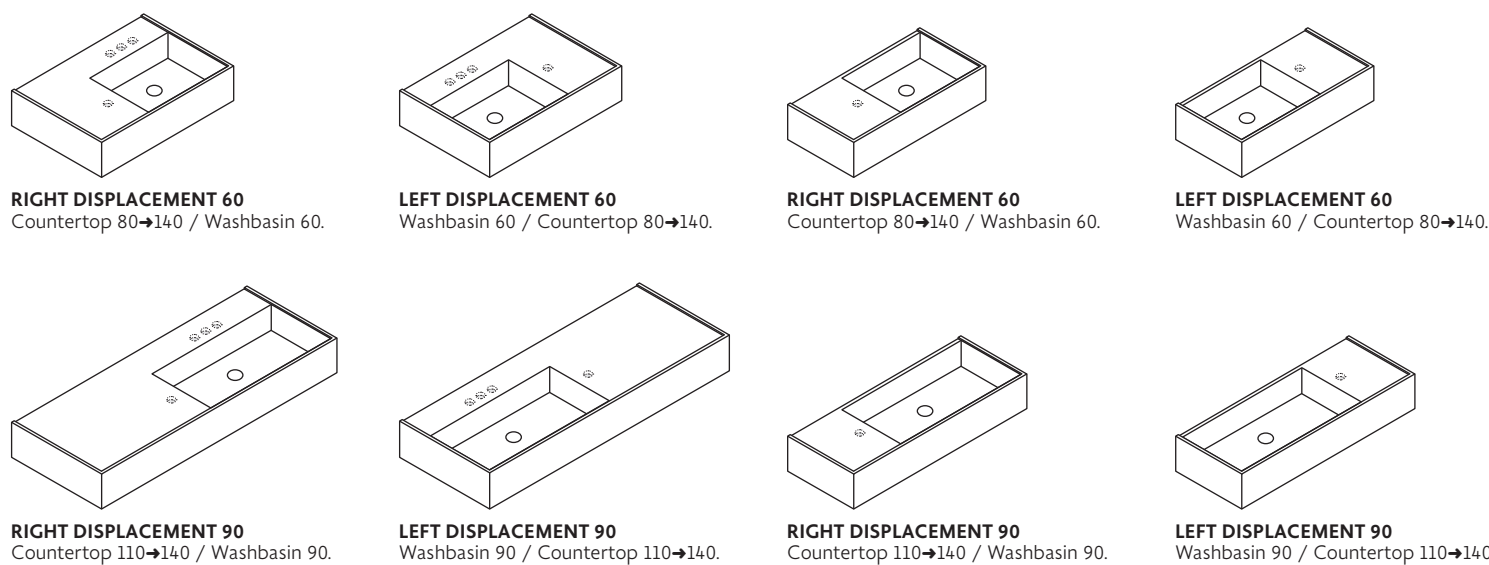
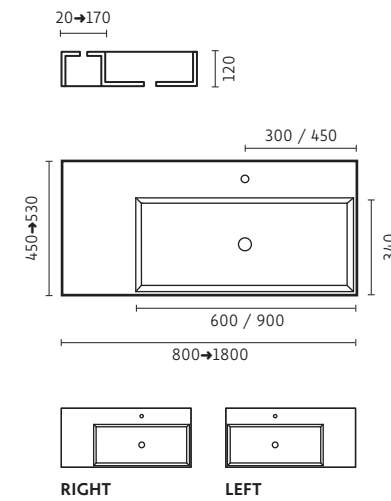

## bari with no perimeter

/60 - 90 cm./

Reference	Width up to	Depth	Height	Washb. 60	Washb. 90
180 OZO 080 1PO	81	36→53	12	800,63	-
180 OZO 090 1PO	91	36→53	12	893,51	-
180 OZO 100 1PO	101	36→53	12	949,23	1.047,69
180 OZO 110 1PO	111	36→53	12	1.030,97	1.129,42
180 OZO 120 1PO	121	36→53	12	1.114,56	1.211,16
180 OZO 140 1PO	141	36→53	12	1.565,96	1.664,41
180 OZO 160 1PO	161	36→53	12	1.762,86	1.861,32
180 OZO 180 1PO	181	36→53	12	2.028,50	2.126,95

- Z=6 Washbasin 60 / Z=9 Washbasin 90 / P=1 Washbasin left / P=2 Washbasin right.
- With rear tap minimum depth 45 cm.
- Valve not included.

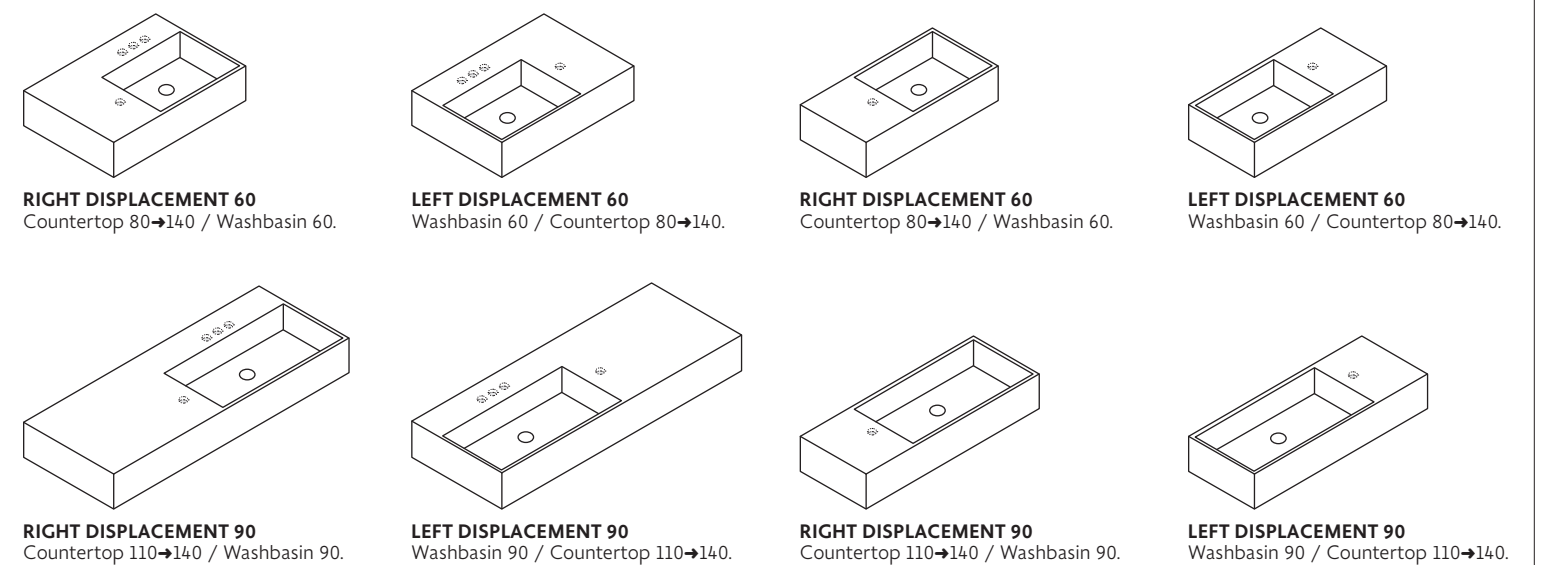
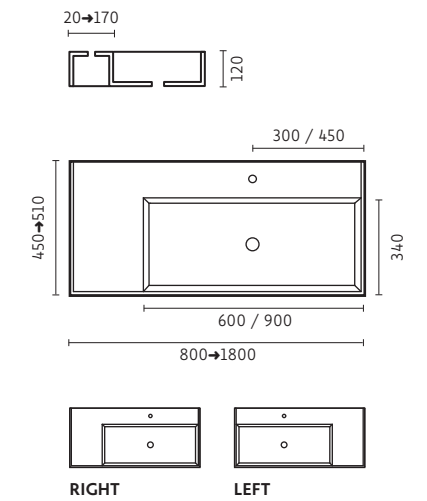

# durian NANTES



nantes

/45 cm./

✓  
STOCK

Reference	Measurement	RRP
378 040 XXX 100	45 x 30 x 14h.	724,46

• Price includes siphon space with chrome cover.

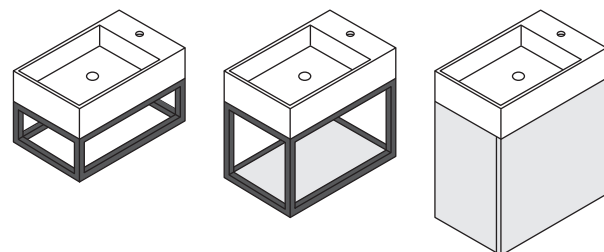
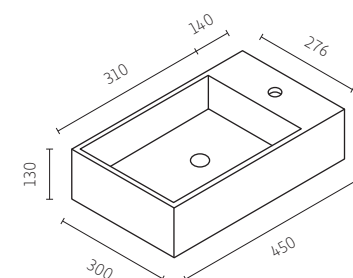

INSTALLATION  
ON FURNITURE  
OR METAL  
STRUCTURE

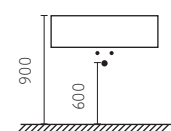

# durian PARMA



parma

/44 cm./

✓  
STOCK

Reference	Measurement	RRP
347 030 045 000	45 x 33 x 1,2h.	481,12

• Price includes siphon space with chrome cover.

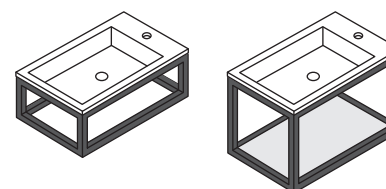
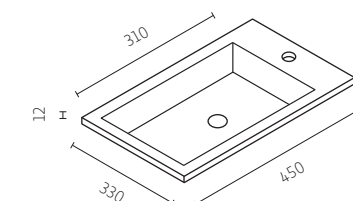

INSTALLATION  
ON METAL  
STRUCTURE

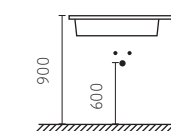



# durian<sup>®</sup> COUNTERTOPS AND WASHBASINS



## durian<sup>®</sup> COUNTERTOP PRICE LIST

### without washbasin

**GROSOR 1.2**  
Countertop for  
countertop washbasin.

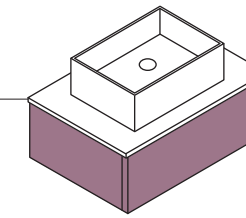

**THICKNESS 3→8**  
Countertop for  
semi-recessed washbasin.

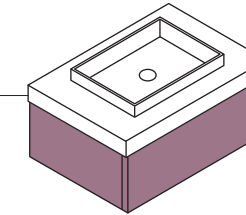

**THICKNESS 8.1→18**  
Countertop without washbasin.

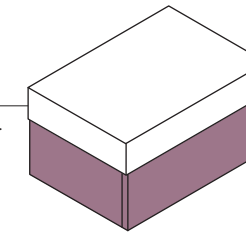

### with washbasin

**GROSOR 1.2**  
Countertop for  
recessed washbasin.

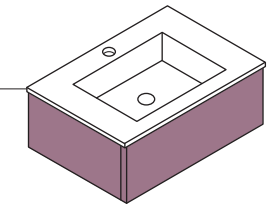

**THICKNESS 3→8**  
Countertop for  
recessed washbasin.

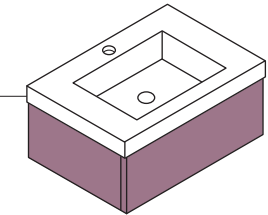

**THICKNESS 8.1→18**  
Countertop for  
recessed washbasin.

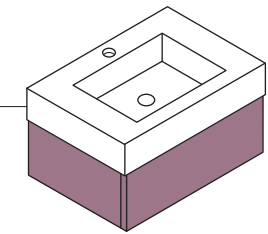

Reference	Width up to	Thickness 1.2	Thickness 3→8	Thickness 8.1→18
501 000 041 Y00	41	239,63	289,79	317,65
501 000 051 Y00	51	261,92	317,65	349,23
501 000 061 Y00	61	287,93	352,94	390,10
501 000 071 Y00	71	312,08	378,95	417,96
501 000 081 Y00	81	338,08	399,38	438,39
501 000 091 Y00	91	365,95	458,83	507,12
501 000 101 Y00	101	395,67	466,26	514,56
501 000 111 Y00	111	421,68	499,69	547,99
501 000 121 Y00	121	455,11	538,70	588,86
501 000 131 Y00	131	482,98	587,00	646,44
501 000 141 Y00	141	512,70	635,30	698,46
501 000 151 Y00	151	547,99	665,02	733,75
501 000 161 Y00	161	577,71	694,74	763,47
501 000 171 Y00	171	611,15	722,61	793,20
501 000 181 Y00	181	689,17	808,06	889,79
501 000 191 Y00	191	726,32	843,35	926,94
501 000 201 Y00	201	761,62	873,07	964,09
501 000 211 Y00	211	796,91	926,94	1.017,96
501 000 221 Y00	221	828,49	965,95	1.062,55

- Y=0 Thickness 1.2 cm / Y=1 Thickness 3→8 cm / Y=2 Thickness 8.1→18 cm.
- The price includes the waste and tap holes for Durian<sup>®</sup> washbasins.
- For washbasins from other manufacturers +£130,03/hole.
- For other widths, please consult price and availability.

Reference	Width up to	Thickness 1.2	Thickness 3→8	Thickness 8.1→18
SSS MMM 061 YP0	61	514,56	635,30	698,46
SSS MMM 071 YP0	71	553,56	672,45	743,04
SSS MMM 081 YP0	81	605,58	713,32	783,91
SSS MMM 091 YP0	91	639,01	795,05	874,93
SSS MMM 101 YP0	101	715,18	847,07	930,66
SSS MMM 111 YP0	111	778,33	919,51	1.012,39
SSS MMM 121 YP0	121	845,21	995,67	1.094,13
SSS MMM 131 YP0	131	984,53	1.198,15	1.315,18
SSS MMM 141 YP0	141	1.127,56	1.398,77	1.536,24
SSS MMM 151 YP0	151	1.218,59	1.486,08	1.632,83
SSS MMM 161 YP0	161	1.311,47	1.571,53	1.729,43
SSS MMM 171 YP0	171	1.426,64	1.690,42	1.861,32
SSS MMM 181 YP0	181	1.541,81	1.809,30	1.989,49
SSS MMM 191 YP0	191	1.638,40	1.900,32	2.089,80
SSS MMM 201 YP0	201	1.733,14	1.991,35	2.190,11
SSS MMM 211 YP0	211	2.058,22	2.383,30	2.621,07
SSS MMM 221 YP0	221	2.379,59	2.773,40	3.039,03

- SSS=Washbasin reference.
- MMM=Washbasin measurements.
- Y=0 Thickness 1.2 cm / Y=1 Thickness 3→8 cm / Y=2 Thickness 8.1→18 cm.
- P=0 Centred washbasin / P=1 Displaced basin.
- Waste and supports not included.



**durian** COUNTERTOPS

DEPTH ≥48 cm WITH REAR TAPS

**pisa flat with cover**

/50 - 59 - 100 cm./



- For 1.2 cm countertop, minimum drawer height 26 cm.
- Minimum unit depth 48 cm (straight handleless 49 cm).
- Increase of cover or washbasin 100 +£ 167,18.
- Compatible with optional click-clack waste.

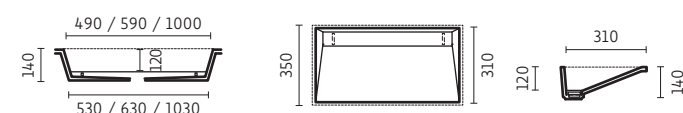

**ferrara with cover**

/50 - 59 cm./



- For 1.2 cm countertop, minimum drawer height 24 cm.
- Minimum unit depth 48 cm.
- Increase of cover +£ 167,18.
- By default, left perimeter cover and tap at 17 cm from the start of the washbasin.



**ferrara without cover**

/50 - 59 cm./



- For 1.2 cm countertop, minimum drawer height 24 cm.
- Minimum unit depth 48 cm.



**sicilia**

/44 - 50 - 60 cm./



- For 1.2 cm countertop, minimum drawer height 26 cm.
- Minimum unit depth 48 cm (straight handleless 49 cm).
- Measurement increments in 60 cm +£92,88.

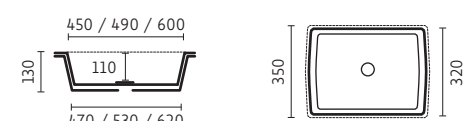

**milano with cover**

/59 cm./



- For 1.2 cm countertop, minimum drawer height 28 cm.
- Minimum unit depth 48 cm (straight handleless 49 cm).
- Increase of cover +£130,03.



**milano without cover**

/59 cm./



- For 1.2 cm countertop, minimum drawer height 28 cm.
- Minimum unit depth 48 cm (straight handleless 49 cm).



**bologna**

/50 cm./



- For 1.2 cm countertop, minimum drawer height 24 cm.
- Minimum unit depth 48 cm.

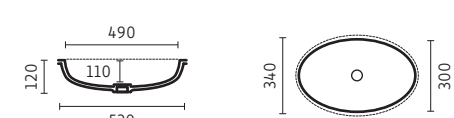

**new napoli**

/Ø32 cm./



- For 1.2 cm countertop, minimum drawer height 24 cm.
- Minimum unit depth 48 cm (straight handleless 49 cm).



**durian** COUNTERTOPS

DEPTH ≥46 cm WITH REAR TAPS

**elba**

/40 - 50 - 60 - 110 cm./



- For 1.2 cm countertop, minimum drawer height 24 cm.
- Minimum unit depth 46 cm.
- Measurement increments in 60 cm +£92,88 and 110 cm +£167,18.

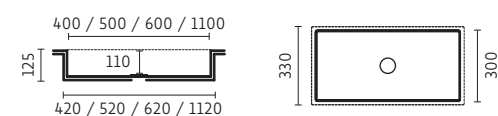

**elba slim**

/50 cm./



- For 1.2 cm countertop, minimum drawer height 24 cm.
- Minimum unit depth 46 cm.



**florence**

/40 - 50 cm./



- For 1.2 cm countertop, minimum drawer height 24 cm.
- Minimum unit depth 46 cm (straight handleless 47 cm).

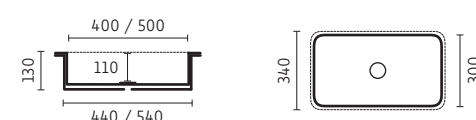

**florence L**

/60 - 80 cm./



- For 1.2 cm countertop, minimum drawer height 28 cm.
- Minimum unit depth 46 cm (straight handleless 47 cm).
- Measurement increments in 60 cm +£92,88 and 80 cm +£130,03.

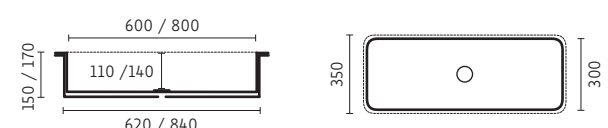

**florence XL**

/100 cm./



- For 1.2 cm countertop, minimum drawer height 28 cm.
- Minimum unit depth 46 cm (straight handleless 47 cm).
- Increase in measurements +£167,18.
- Optional 2nd tap hole +£ 55,73.

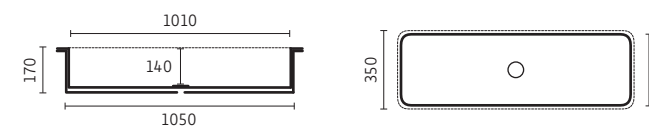

**new siena**

/45 cm./



- For 1.2 cm countertop, minimum drawer height 24 cm.
- Minimum unit depth 46 cm.



**new capri**

/50 cm./



- For 1.2 cm countertop, minimum drawer height 24 cm.
- Minimum unit depth 46 cm.



**venecia**

/59 cm./



- For 1.2 cm countertop, minimum drawer height 24 cm.
- Minimum unit depth 46 cm (straight handleless 47 cm).
- Only valid for washbasin units with a minimum width of 75 cm.



**durian** COUNTERTOPS

DEPTH ≥40 cm WITH REAR TAPS

**siena mini**

/48 cm./



- For 1.2 cm countertop, minimum drawer height 24 cm.
- Minimum unit depth 40 cm.



**turin**

/33 cm./



- For 1.2 cm countertop, minimum drawer height 24 cm.
- Minimum unit depth 40 cm (straight handleless 41 cm).



**elba mini**

/40 cm./



- For 1.2 cm countertop, minimum drawer height 26 cm.
- Minimum unit depth 40 cm (straight handleless 41 cm).



**florence mini**

/40 cm./



- For 1.2 cm countertop, minimum drawer height 26 cm.
- Minimum unit depth 40 cm.



**durian** CUTS IN COUNTERTOPS



**straight**

Reference	Cut	RRP
901 100 000 007	L	111,46
901 100 000 002	U	111,46
901 100 000 003	diagonal	111,46

- Cuts valid for 1.2 cm thick countertops.
- Indicate cut dimensions.



**oval curved**

Reference	RRP
901 100 000 005	167,18

- Cuts valid for 1.2 cm thick countertops.
- Indicate cut dimensions and confirm viability.



**rounded corner**

Reference	RRP
901 100 000 004	55,73

- Cuts valid for 1.2 cm thick countertops.
- Indicate radius



**ola curved**

Reference	RRP
901 100 000 008	278,64

- Cuts valid for 1.2 cm thick countertops.
- Indicate cut dimensions and confirm viability.





durian CONTOUR LINE

contour line wet area

Reference	Measurement	RRP
901 100 000 042	up to 100	222,91

- 1 cm wide frame.
- Minimum chargeable 1 metre.

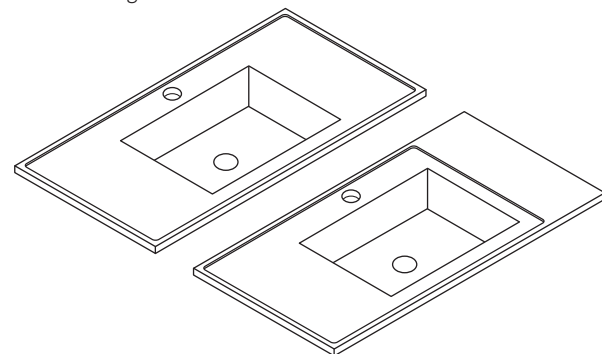

contour line soap dish

Reference	Measurement	RRP
901 100 000 040	8 x 10	111,46

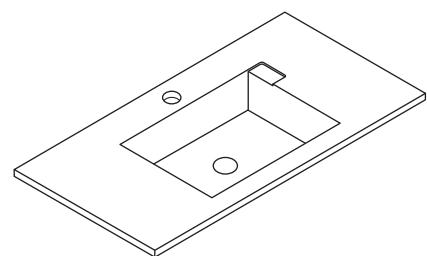

contour line amenities

Reference	Measurement	RRP
901 100 000 041	up to 20 x 40	148,61

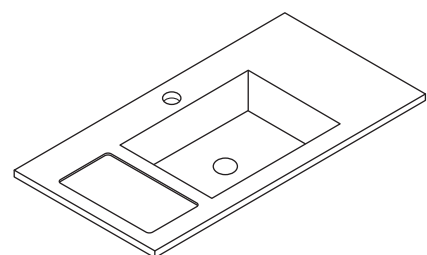

durian MACHINING

slim line 6 mm

Reference	Milling	Width up to 120	Width 121-220
901 100 000 081	front	148,61	222,91
901 100 000 082	left	74,30	-
901 100 000 083	right	74,30	-

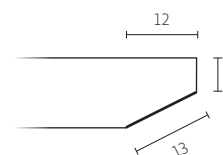

machining countertop cover

Reference	Machining	RRP
901 100 000 056	ROMA	148,61
901 100 000 057	NEW POMPEI	222,91

- Thickness 1.2 cm. Minimum depth 50 cm.

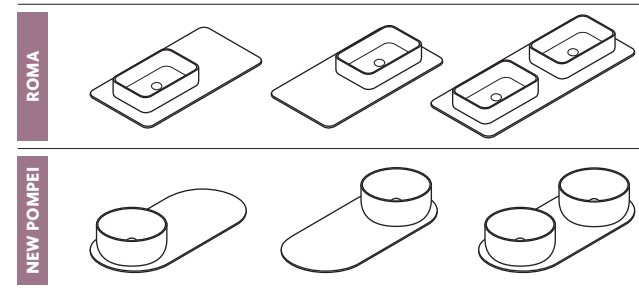

machining countertop cover

Reference	Machining	RRP
901 100 000 058	radius 20	222,91

- Thickness 1.2 cm. Minimum depth 50 cm.

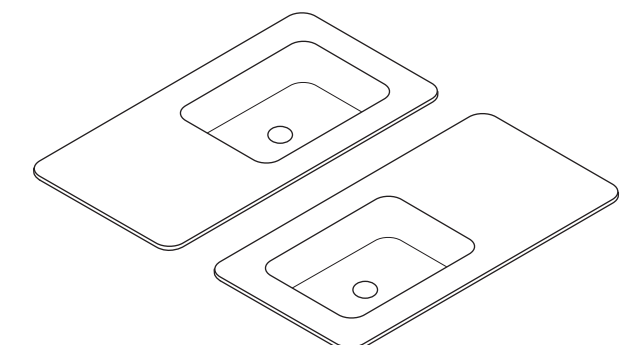



## durian TOWEL HOLDERS

### top towel holder

Reference	Measurement	Width 30→50
901 100 000 035	left	167,18/unit
901 100 000 037	Right	167,18/unit

- Minimum overhang 8 cm (2+4+2).
- Add 10 cm to the width of the countertop.

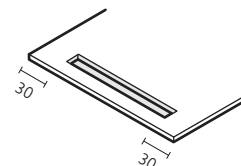

### front/side towel holder

Reference	Measurement	RRP
901 100 000 031	0→30 cm	130,03/unit
901 100 000 031	30.1→50 cm	148,61/unit
901 100 000 031	50.1→70 cm	167,18/unit

- Indicate position.
- Height centred.
- Minimum top panel height 8 cm.

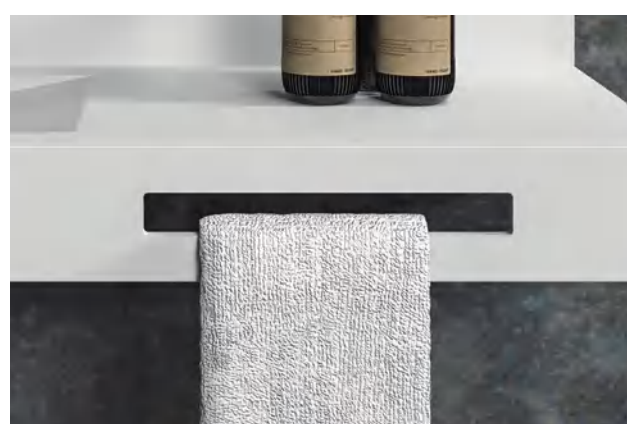
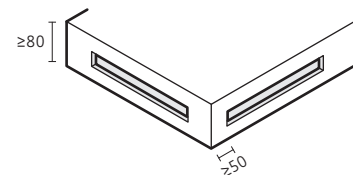

### structure towel holder

Reference	Measurement	RRP
901 100 000 029	0→30 cm	130,03/unit
901 100 000 029	30.1→50 cm	148,61/unit
901 100 000 029	50.1→80 cm	167,18/unit

- Indicate position.
- Minimum top panel height 8 cm.

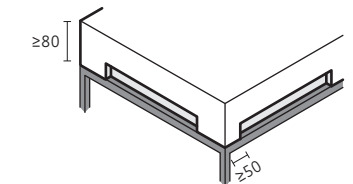

### verso towel holder + machining

Reference	Measurement	RRP
901 100 000 096	38,5 x 5 x 3,5h	139,32

- Supplied separately, indicate position.

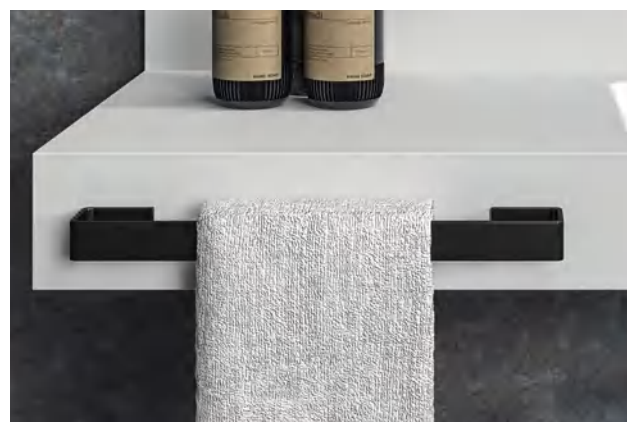
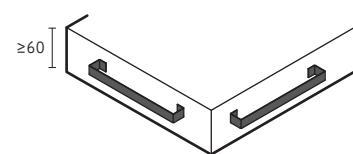

## durian COMPLEMENTS

### overflow + pipe

Reference	RRP
901 100 000 014	148,61

- Not valid for Venezia, New Naples and Bologna.
- Only centred option.

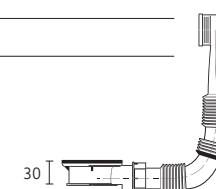

### straight seamless backsplash

Reference	Measurement	RRP
503 XXX YYY 110	6 cm	111,46/m.
503 XXX YYY 110	7→15 cm	148,61/m.
503 XXX YYY 110	16→35 cm	260,06/m.

- Minimum chargeable 1 metre. Separate backsplash without countertop +€55,73.
- Tap hole +€55,73/unit Tap hole depth (Ø>5 cm) +€ 167,18/unit.



### rounded seamless backsplash

Reference	Measurement	RRP
503 XXX YYY 120	6 cm	278,64/m.
503 XXX YYY 120	7→15 cm	334,37/m.
503 XXX YYY 120	16→35 cm	390,10/m.

- Tap hole +€55,73/unit Tap hole depth (Ø>5 cm) +€167,18/unit.



### extra washbasin

RRP
222,91/unit

- The location is fully customisable.



### XL depth

Measurement	RRP
53→65 cm	+20%





# durian<sup>®</sup> ON CONCEPT

## durian<sup>®</sup> TODI

**todi** countertop washbasin

/Ø40 cm./

✓  
STOCK

Reference	Measurement	Durian <sup>®</sup>
178	Ø40 x 14h.	715,18

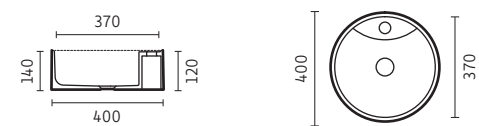

## durian<sup>®</sup> FORLI

**forli** countertop washbasin

/40 cm./

✓  
STOCK

Reference	Measurement	Durian <sup>®</sup>
183	40 x 40 x 14h.	687,31



## durian<sup>®</sup> RHO

**rho** countertop washbasin

/Ø40 cm./

✓  
STOCK

Reference	Measurement	Durian <sup>®</sup>
181	Ø40 x 14h.	622,30

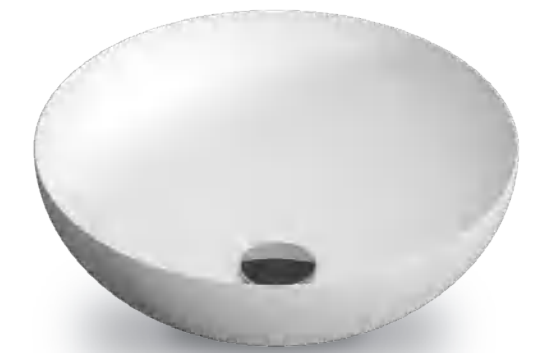
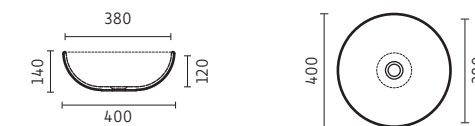

## durian<sup>®</sup> SONA

**sona** countertop washbasin

/41 cm./

✓  
STOCK

Reference	Measurement	Durian <sup>®</sup>
184	41 x 34 x 15h.	622,30

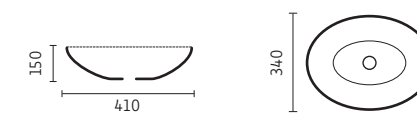

# durian ROMA

## roma countertop washbasin

/43 - 53 - 63 - 83 - 103 cm./

STOCK

Ref.	Measurement	Durian*	Matt Select Lacquer	Gold
146	43 x 33 x 13h.	613,01	915,80	1.006,82
	53 x 33 x 13h.	663,16	956,66	1.053,26
	63 x 33 x 15h.	704,03	1.023,54	1.125,71
	83 x 33 x 15h.	819,20	1.149,85	1.265,03
	103 x 33 x 15h.	952,95	1.279,89	1.408,06



• 678100

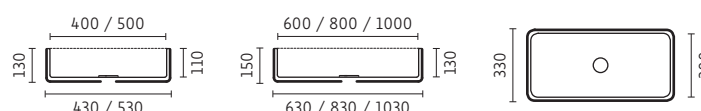

## roma semi-recessed

/43 - 53 cm./

STOCK

Ref.	Measurement	Durian*	Matt Select Lacquer	Gold
176	43x33x13h.	613,01	915,80	1.006,82
	53x33x13h.	663,16	956,66	1.053,26

\* Perimeter recess 0.5 cm.

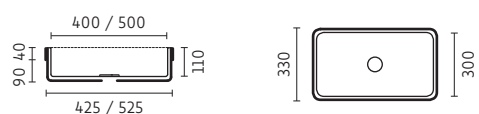

# durian GENOVA

## genova countertop washbasin

/54 cm./

STOCK

Ref.	Measurement	Durian*	Matt Select Lacquer	Gold
145	54.5 x 33 x 15.5h.	678,02	1.034,68	1.138,71



## genova semi-recessed

/54 cm./

STOCK

Ref.	Measurement	Durian*	Matt Select Lacquer	Gold
175	54.5 x 33 x 15.5h.	678,02	1.034,68	1.138,71

\* Perimeter recess 0.5 cm.





# durian VERONA

## verona countertop washbasin

/63 cm./

✓  
STOCK

Ref.	Measurement	Durian*	Matt Select Lacquer	Gold
144	63 x 35 x 15.5h.	724,46	993,82	1.094,13

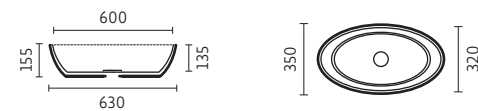

## verona semi-recessed

/63 cm./

✓  
STOCK

Ref.	Measurement	Durian*	Matt Select Lacquer	Gold
174	63 x 35 x 15.5h.	724,46	993,82	1.094,13

• Perimeter recess drop 0.5 cm.



# durian NEW POMPEI

## new pompeii countertop washbasin

/Ø40 cm./

✓  
STOCK

Ref.	Measurement	Durian*	Matt Select Lacquer	Gold
170	Ø40 x 13,5h	685,45	995,67	1.095,98



## new pompeii semi-recessed

/Ø40 cm./

✓  
STOCK

Ref.	Measurement	Durian*	Matt Select Lacquer	Gold
172	Ø40 x 13,5h	685,45	995,67	1.095,98

• Perimeter recess drop 0.5 cm.



# durian NEW TRENTO

## new trento countertop washbasin

/37 cm./

STOCK

Ref.	Measurement	Durian*	Matt Select Lacquer	Gold
171	37 x 37 x 12h.	640,87	947,38	1.042,11



## new trento semi-recessed

/37 cm./

STOCK

Ref.	Measurement	Durian*	Matt Select Lacquer	Gold
173	37 x 37 x 12h.	640,87	947,38	1.042,11

\* Perimeter recess drop 0.5 cm.

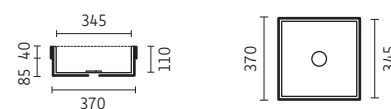

## new trento height XL

/37 cm./

Ref.	Measurement	Durian*
371	37 x 37 x 20→30h.	1.058,83

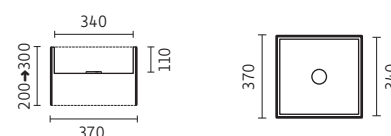

# durian PALERMO

## palermo countertop washbasin

/50 cm./

STOCK

Ref.	Measurement	Durian*	Matt Select Lacquer	Gold
177	37 x 37 x 12h.	702,17	1.016,11	1.118,28

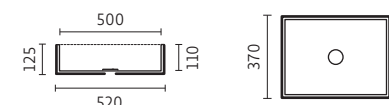

## palermo semi-recessed

/50 cm./

STOCK

Ref.	Measurement	Durian*	Matt Select Lacquer	Gold
182	50 x 37 x 12h.	702,17	1.016,11	1.118,28

\* Perimeter recess drop 0.5 cm.

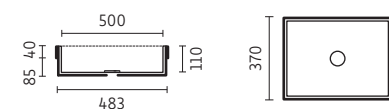

## palermo height XL

/50 cm./

Ref.	Measurement	Durian*
377	50 x 37 x 20→30h.	1.164,72

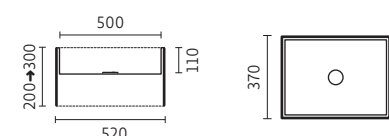

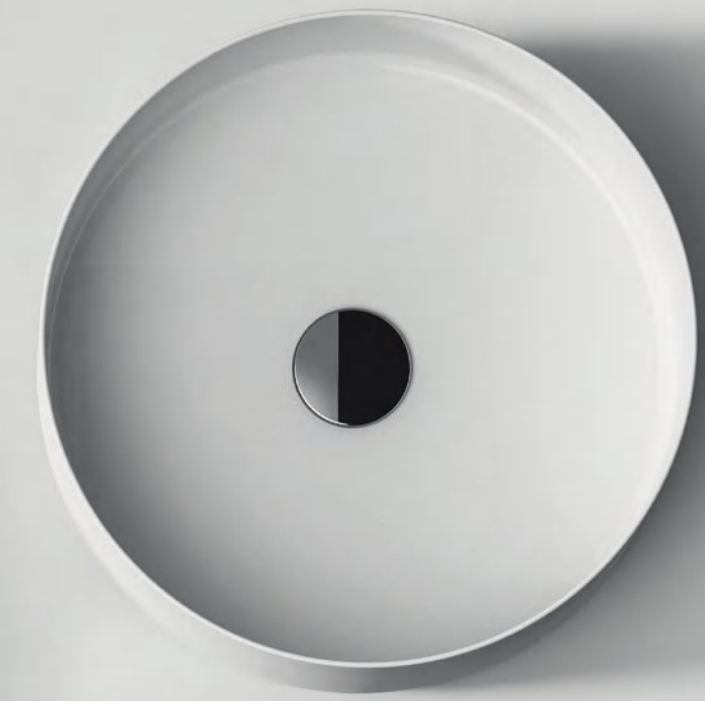

CERAMIC

# CERAMIC EXCLUSIVE



VERY HARD



HIGH QUALITY



THICKNESS SUPERFINE

## exclusive calacatta

/Ø40 cm./



HAND PAINTED



MATT FINISH

Reference	Measurement	RRP
V180NC	Ø40 x 14h.	1.374,62

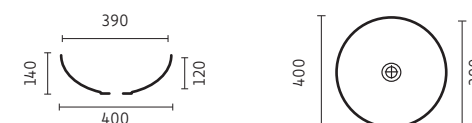

## exclusive marquina

/Ø40 cm./



HAND PAINTED



MATT FINISH

Reference	Measurement	RRP
V180NM	Ø40 x 14h.	1.374,62

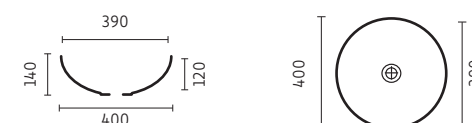

## exclusive white

/Ø40 cm./



GLOSS WHITE

Reference	Measurement	RRP
V180NB	Ø40 x 14h.	306,50

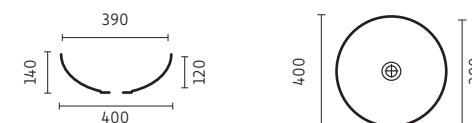



SCRATCH  
RESISTANT



HIGH  
QUALITY



CHEMICAL  
RESISTANCE

### essential

/42 cm./



GLOSS  
WHITE

Reference	Colour	Measurement	RRP
V1001N040	White	42 x 42 x 16h.	297,22

• Enamelled 4 sides.



### superfine bowl

/Ø35 cm./



GLOSS  
WHITE



SUPERFINE  
THICKNESS

Reference	Colour	Measurement	RRP
V1501N035	White	Ø35 x 11h.	287,93



### oval light

/41 cm./



GLOSS  
WHITE

Reference	Colour	Measurement	RRP
V1201N041	White	41 x 34 x 15h.	250,78

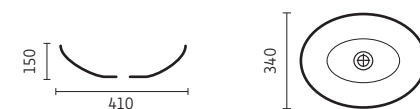

OPTIONAL  
COLOUR



HIGH  
QUALITY



SUPERFINE  
THICKNESS

### new stadium superfine

/46 cm./



GLOSS  
WHITE



MATT  
BLACK

Reference	Colour	Measurement	RRP
V130NB	Gloss white	46 x 32,5 x 13sh.	260,06
V130NN	Matt black	46 x 32,5 x 13sh.	408,67

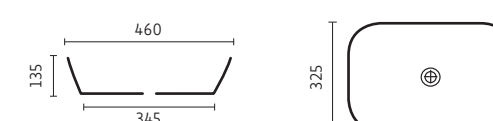

### circle superfine

/Ø36 cm./



GLOSS  
WHITE



MATT  
BLACK

Reference	Colour	Measurement	RRP
V140NB	Gloss white	Ø36 x 11h.	334,37
V140NN	Matt black	Ø36 x 11h.	427,25



### new square superfine

/36 cm./



GLOSS  
WHITE



MATT  
BLACK

Reference	Colour	Measurement	RRP
V160NB	Gloss white	36 x 36 x 11h.	362,23
V160NN	Matt black	36 x 36 x 11h.	538,70



# CERAMIC RIVER



## river 46 centred

Reference	M2	M1	M3	M9	M11	H	V	RRP
RV010NN061	61	46	Cent.	52	27	12	17	260,06
RV010NN071	71	46	Cent.	52	27	12	17	287,93
RV010NN081	81	46	Cent.	52	27	12	17	315,79
RV010NN091	91	46	Cent.	52	27	12	17	343,66
RV010NN101	101	46	Cent.	52	27	12	17	362,23
RV010NN121	121	46	Cent.	62	27	12	17	547,99

• For straight handleless and Gola in P2.

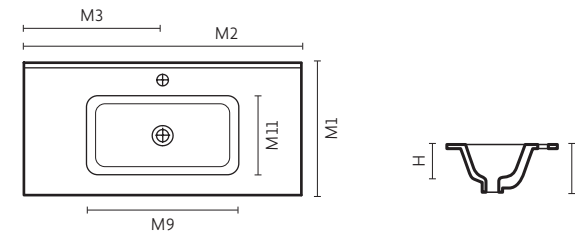

## river 46 off-centre right/left

Reference	Wash-basin	M2	M1	M3	M9	M11	H	V	RRP
RV020NN091	left	91	46	30.5	44	26	12	17	408,67
RV020NN101	left	101	46	36	52	26	12	17	436,54
RV050NN091	right	91	46	30.5	44	26	12	17	408,67
RV050NN101	right	101	46	36	52	26	12	17	436,54

• For straight handleless and Gola in P2.

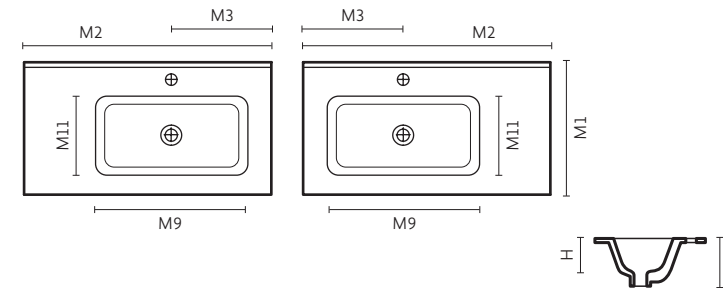

LEFT

## river 40 reduced depth centred

Reference	M2	M1	M3	M9	M11	H	V	RRP
RV030NN061	61	40	Cent.	43	22	12	17	260,06
RV030NN071	71	40	Cent.	43	22	12	17	287,93
RV030NN081	81	40	Cent.	43	22	12	17	315,79

• For straight handleless and Gola in P2.

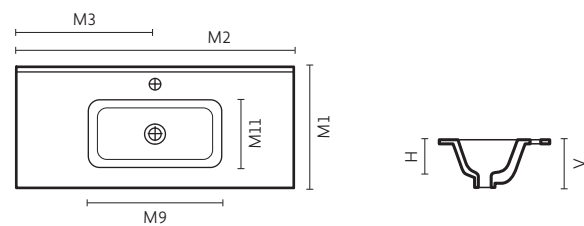

## river 46 double washbasin

Reference	M2	M1	M3	M9	M11	H	V	RRP
RV040NN121	121	46	30.5	41	27	12	17	631,58
RV040NN141	141	46	35.5	50	27	12	17	965,95

• For straight handleless and Gola in P2.

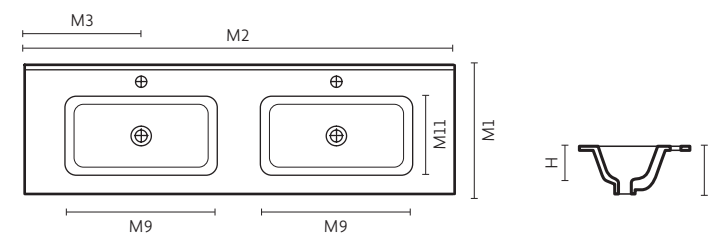

# CERAMIC CUADRO



## cuadro 46 centred



Reference	M2	M1	M3	M9	H	V	RRP
V0101N061	61	46	Cent.	44	13	17	213,62
V0101N071	71	46	Cent.	49	13	17	232,20
V0101N081	81	46	Cent.	49	13	17	250,78
V0101N091	91	46	Cent.	49	13	17	306,50
V0101N101	101	46	Cent.	49	13	17	352,94
V0101N121	121	46	Cent.	50	13	17	492,26

• For straight handleless and Cola in P2.

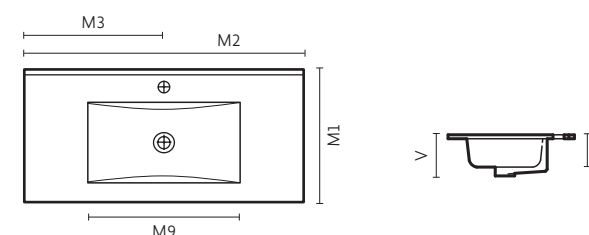

## cuadro 46 off-centre right/left

Reference	Wash-basin	M2	M1	M3	M9	H	V	RRP
V0311N091	left	91	46	34.5	48	13	17	445,82
V0311N101	left	101	46	36.5	51	13	17	538,70
V0311N121	left	121	46	40	51	13	17	724,46
V0321N091	right	91	46	34.5	48	13	17	445,82
V0321N101	right	101	46	36.5	51	13	17	538,70
V0321N121	right	121	46	40	51	13	17	724,46

• For straight handleless and Gola in P2.

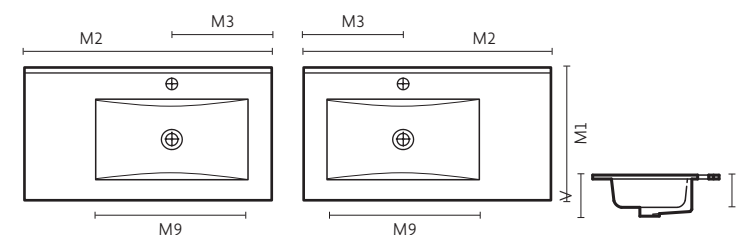

LEFT

## cuadro mini 36 reduced depth centred

Reference	M2	M1	M3	M9	H	V	RRP
V0401N061	61	36.5	Cent.	44	9.5	14	232,20
V0401N071	71	36.5	Cent.	44	9.5	14	312,08
V0401N081	81	36.5	Cent.	44	9.5	14	323,22

• Always in P2.

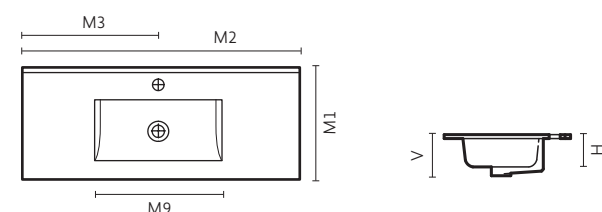

## cuadro 46 double washbasin

Reference	M2	M1	M3	M9	H	V	RRP
V0102N121	121	46	30.5	41	12	17	659,45

• For straight handleless and Gola in P2.

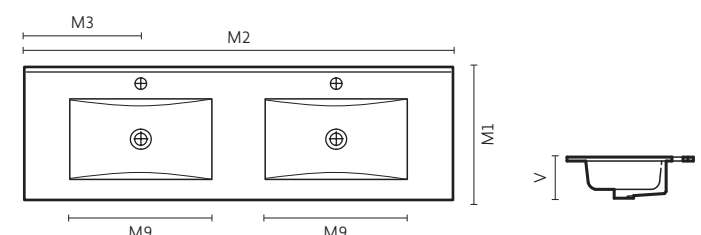

# 2022

## FINISHES **KYRYA**

---

FANTASY

---

ARLUX

---

FENIX

---

WOOD

---

SELECT MATT LACQUER

---

RAL LACQUER

---

# FANTASY

## SPACES THAT ACCOMPANY YOUR LIFE

The dream entrance to your KYRYA® space.

### forest

Laminated panels that recreate wood with great delicacy, from the Nordic minimalist touch, to the most stylish cosmopolitan oak, the best option for those who wish to create an atmosphere of illusion and fantasy in their bathroom.

### colors

Laminated panels full of colour and fantasy, chosen to create a perfect harmony of colours no matter how you combine them, explore your creativity and add colour to your life.



# forest

## FANTASY

Laminated panels that recreate wood with great delicacy, from the Nordic minimalist touch, to the most stylish cosmopolitan oak, the best option for those who wish to create an atmosphere of illusion and fantasy in their bathroom.



FAMA01  
WHITE OAK

FAMA13  
NORDIC

FAMA03  
PUCCINI OAK



FAMA11  
WINTER ELM



FAMA12  
ANDES OAK



FAMA05  
JET OAK



# colors

## FANTASY

Laminated panels full of colour and fantasy, chosen to create a perfect harmony of colours no matter how you combine them, explore your creativity and add colour to your life.

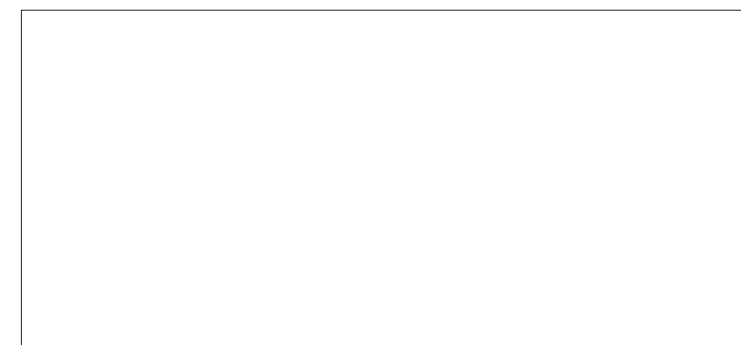

FACO01 **WHITE**

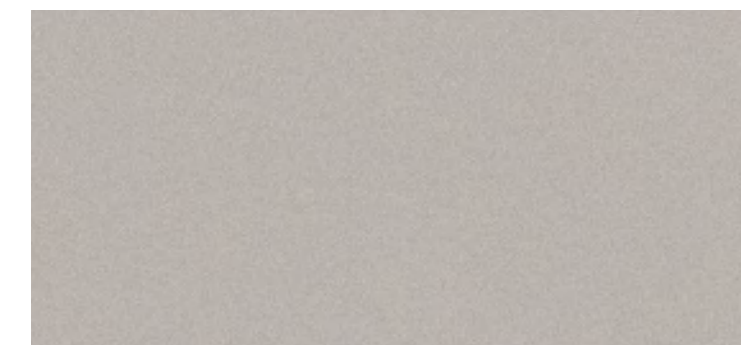

FACO02 **GREY**

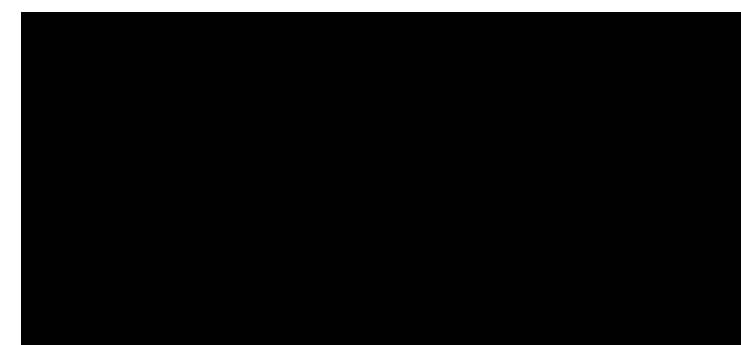

FACO03 **DARK GREY**

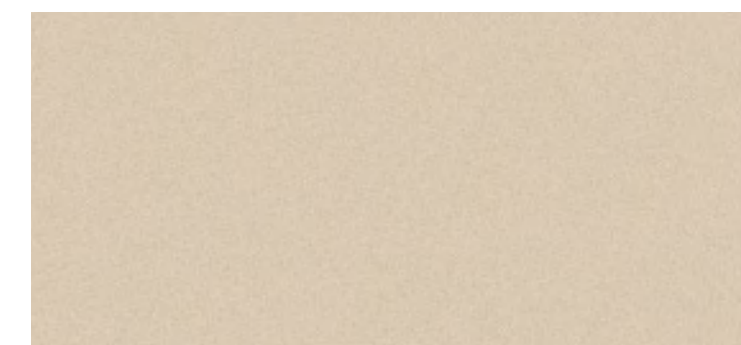

FACO04 **BISCUIT**

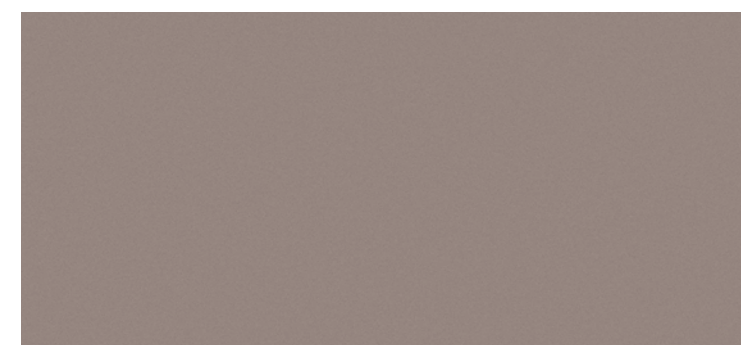

FACO07 **NEW TAUPE**

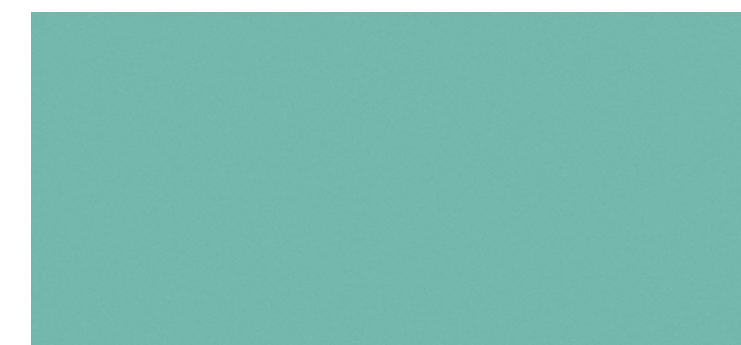

FACO08 **SKY**

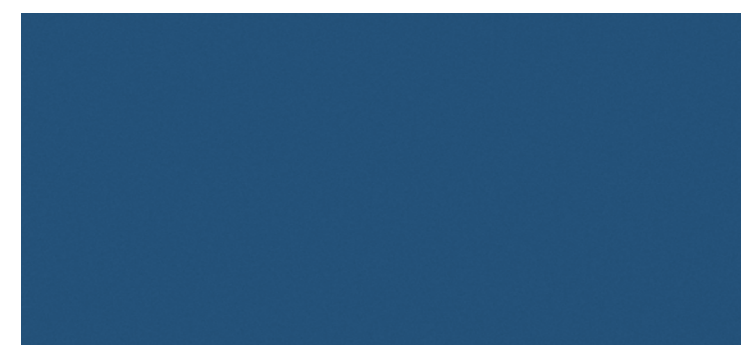

FACO09 **MARINE**



FACO10 **IRELAND**



FACO11 **MUSTARD**

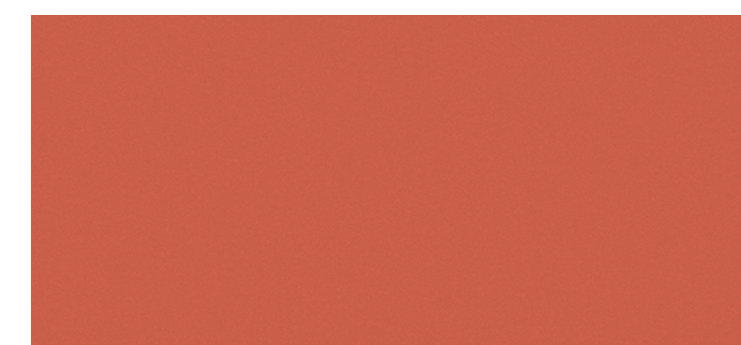

FACO12 **CLAY**

# ARLUX

## ART AND LUXURY BECOME MATERIAL

Where the design and the quality of the materials are perceived.

## gravel

The **GRAVEL** series by ARLUX transport us to the stony riverbeds as inspiration for these finishes full of details and textures. 3 finishes that combine perfectly in any bathroom, offering a natural stylish look. They are made using high pressure systems to achieve a texture and resistance to meet the quality standards of our ARLUX range.

## touch

The **TOUCH** series by ARLUX is inspired by the material sincerity of industrial elements to give the furniture that look so closely linked to design architecture. Each finish has a perfectly studied touch and texture to achieve that feeling of realism and high quality finishes that KYRYA® offers you in our ARLUX range.

## feel

The **FEEL** series by ARLUX aims to transport you to other places, a stylish ash latticework gives us an insight into the landscapes of the world. Four designs with a texture full of depth and sensations. Timeless, sober and stylish woods to make your bathroom a paradise.

## wood

The **WOOD** series by ARLUX has been selected for those who appreciate the rusticity of wood and wish to make their bathroom furniture a truly personal piece. The deep marks and knots of these three designs are truly impressive, and thanks to the three shades that KYRYA® offers you can adapt it to your own style.

## oak

In the **OAK** series by ARLUX we considered one of the lightest furniture woods there is, always full of variety, oak and its different species are essential in a piece of furniture that evokes quality and authenticity. We have selected for you three species from the most neutral and stylish to the most rustic and greyish for a vintage industrial look.

## marble

**MARBLE** by ARLUX is essence and sincerity, two unalterable and timeless classic finishes. Discover the new textures of these finishes and create a bathroom space that exudes quality and unique style.  
**HPL BRIGHTNESS WHITE** always a classic that cannot be missed.



ARLUX

# gravel

The **GRAVEL** series by ARLUX transport us to the stony riverbeds as inspiration for these finishes full of details and textures. 3 finishes that combine perfectly in any bathroom, offering a natural stylish look. They are made using high pressure systems to achieve a texture and resistance to meet the quality standards of our ARLUX range.



ARGR01  
SOFT



ARGR03  
LIGHT

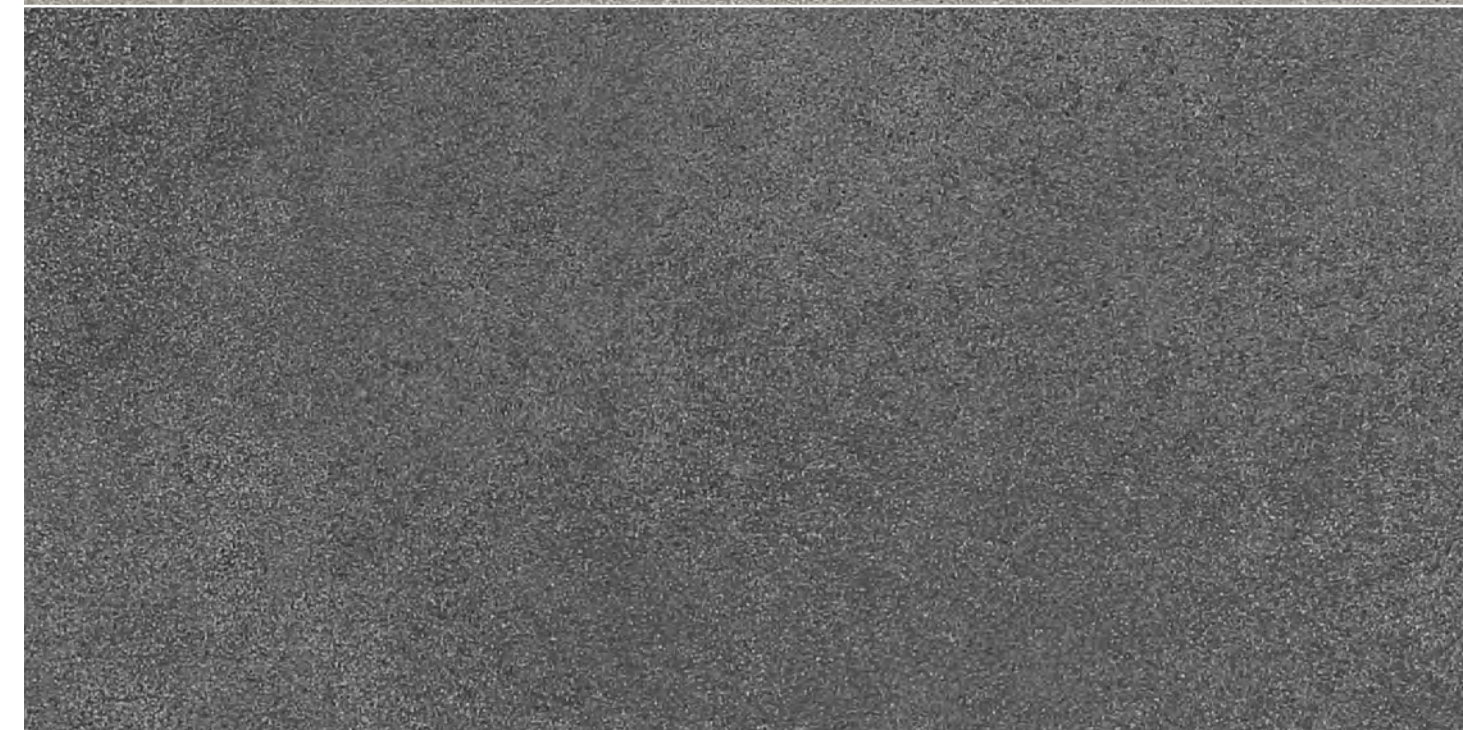

ARGR02  
DARK



ARLUX  
touch

The **TOUCH** series by ARLUX is inspired by the material sincerity of industrial elements to give the furniture that look so closely linked to design architecture. Each finish has a perfectly studied touch and texture to achieve that feeling of realism and high quality finishes that KYRYA® offers you in our ARLUX range.



ARTO01  
ROC



ARTO02  
DESERT

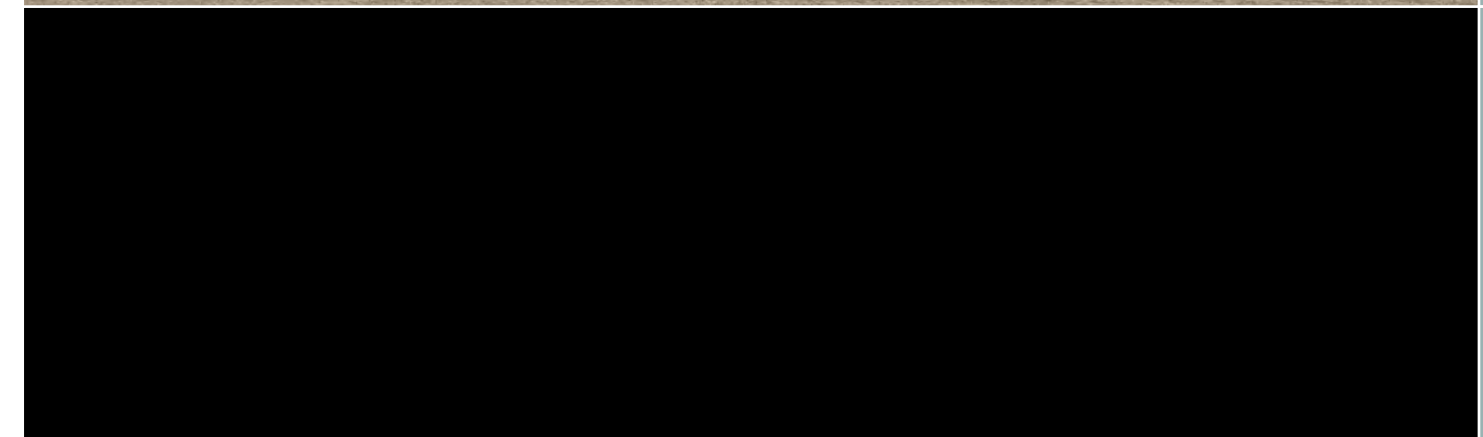

ARTO03  
LAVA

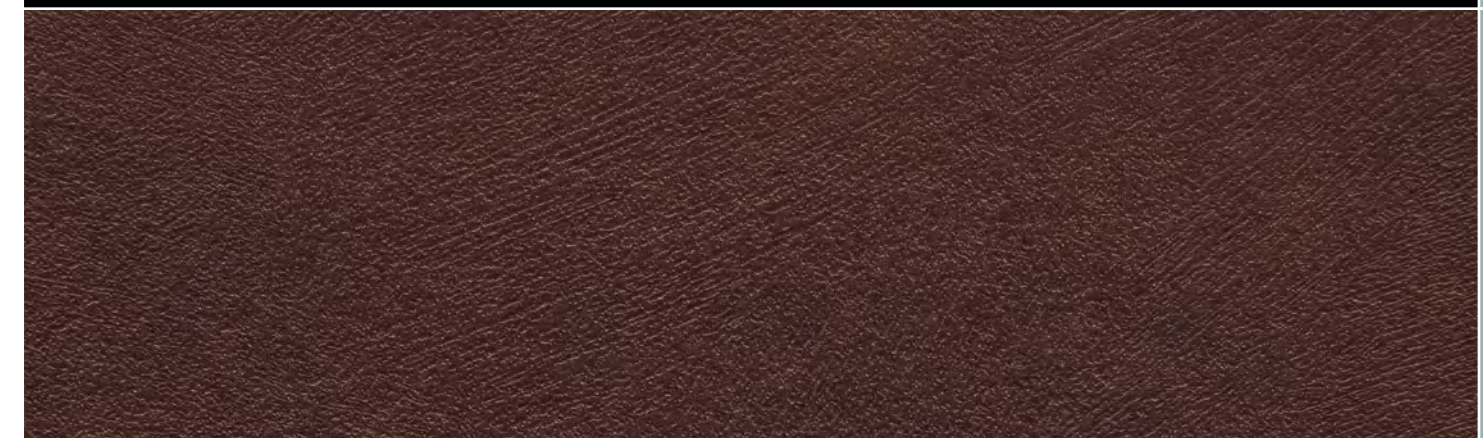

ARTO04  
CORTEN STEEL



ARTO05  
TAUPE

ARLUX  
**feel**

The **FEEL** series by ARLUX aims to transport you to other places, a stylish ash latticework gives us an insight into the landscapes of the world. Four designs with a texture full of depth and sensations. Timeless, sober and stylish woods to make your bathroom a paradise.



ARFE01  
ARABIA

ARFE02  
JUNGLE

ARFE03  
SIBERIA

ARFE04  
INDONESIA



ARLUX  
wood

The **WOOD** series by ARLUX has been selected for those who appreciate the rusticity of wood and wish to make their bathroom furniture a truly personal piece. The deep marks and knots of these three designs are truly impressive, and thanks to the three shades that KYRYA® offers you can adapt it to your own style.

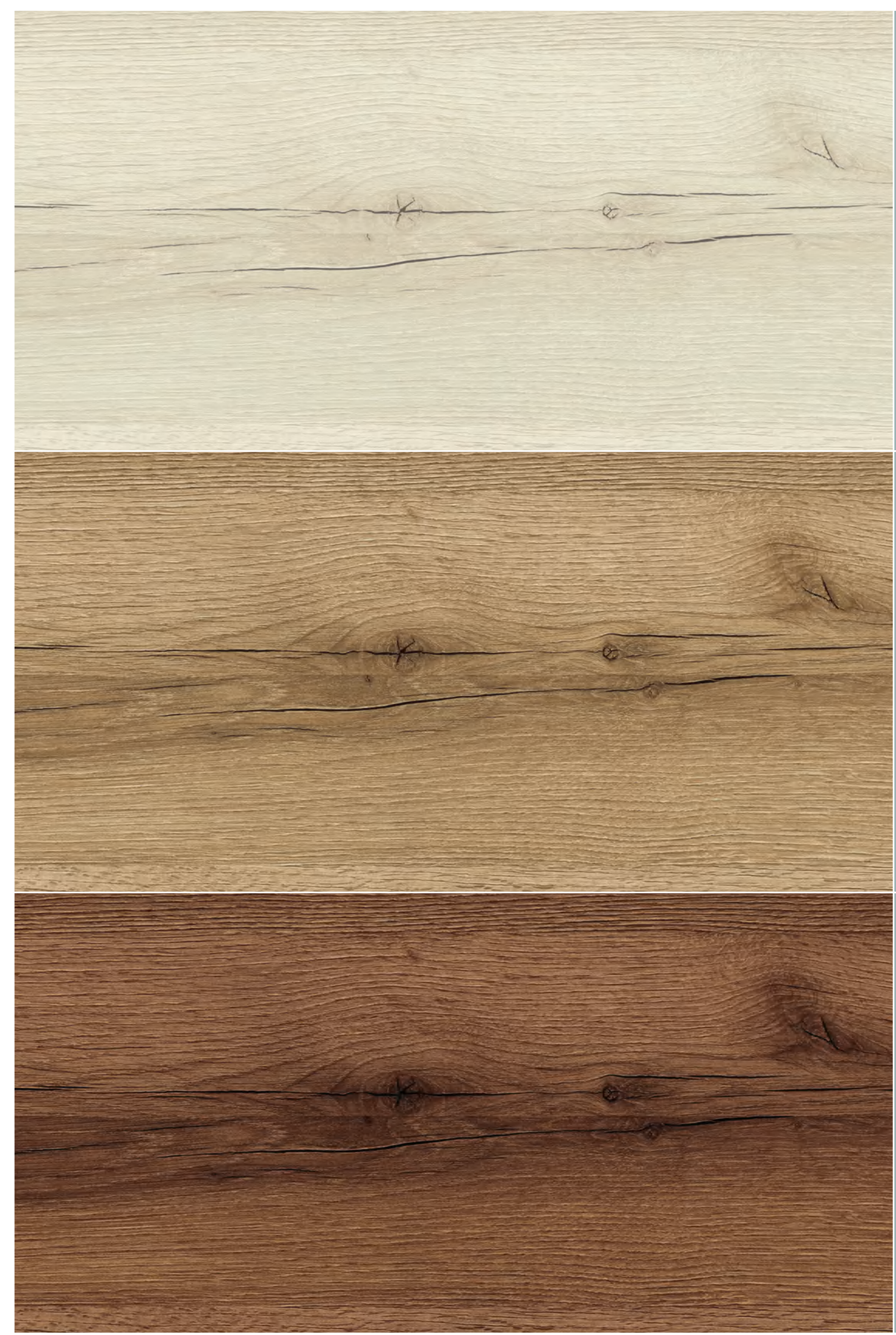

ARWOOD8  
ARCTIC

ARWOOD3  
LEGNO

ARWOOD7  
TOBACCO





ARLUX  
oak

In the **OAK** series by ARLUX we considered one of the lightest furniture woods there is, always full of variety, oak and its different species are essential in a piece of furniture that evokes quality and authenticity. We have selected for you three species from the most neutral and stylish to the most rustic and greyish for a vintage industrial look.

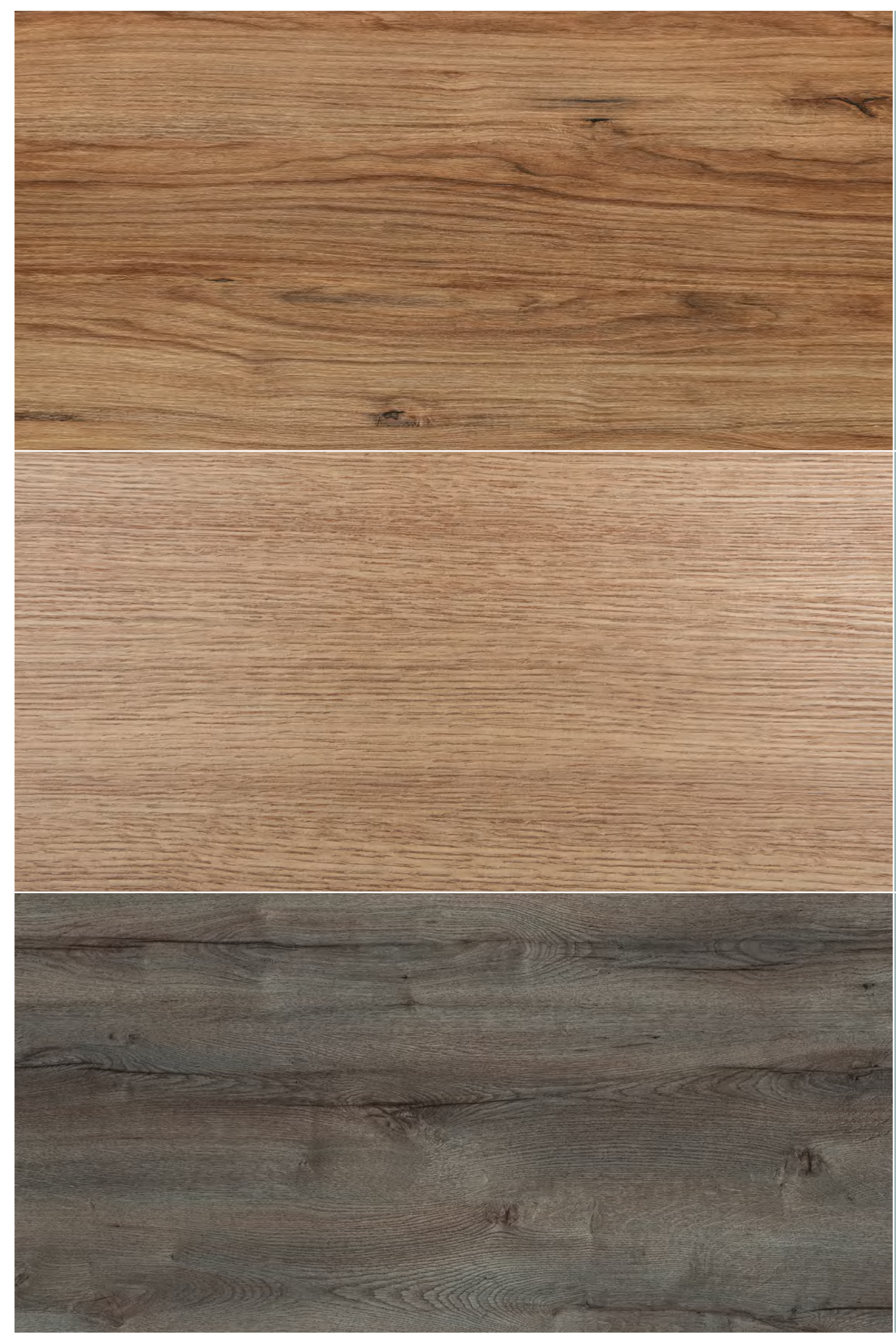

ARRO01  
SIERRA OAK

ARRO02  
NATURAL OAK

ARRO03  
ASH GREY OAK



ARLUX  
**marble**

**MARBLE** by ARLUX is essence and sincerity, two unalterable and timeless classic finishes. Discover the new textures of these finishes and create a bathroom space that exudes quality and unique style.

**HPL BRIGHTNESS WHITE**  
 Always a classic that cannot be missed.



ARMA04  
**CALACATTA 21**



ARMA05  
**MARQUINA 21**



ARCO01  
**HPL BRIGHTNESS WHITE**

# FENIX®

NANOTECH MATT MATERIAL  
FOR INTERIOR DESIGN.  
MADE IN ITALY



ULTRA-MATTE  
SURFACE



EXCELLENT  
COLOUR



WATER-  
REPELLENT



EASY-  
CLEAN



ANTI-BACTERIAL  
PROPERTIES

**FENIX®** is a super-matte nano-technological material for interior design which combines elegant aesthetic solutions with cutting edge technological features. It is an innovative material created for interior design by Arpa Industriale and is suitable for both vertical and horizontal applications. The outer surface of **FENIX®** is achieved through the use of nanotechnology and is characterised by the use of acrylic resins. These are hardened and set by means of Electron Beam Curing, which has opened up a heretofore unexplored path in interior design. Reflecting back very little light, its surface is ultramatte and fingerprint-proof, plus pleasant and soft to the touch. As a result of nanotechnology, **FENIX®** can regenerate following micro-scratches on the surface through a thermal repair process, as its very name suggests.



FINGERPRINT-  
PROOF



SHOCK-  
RESISTANT



CHEMICAL  
RESISTANT



REPAIRED  
THERMALLY

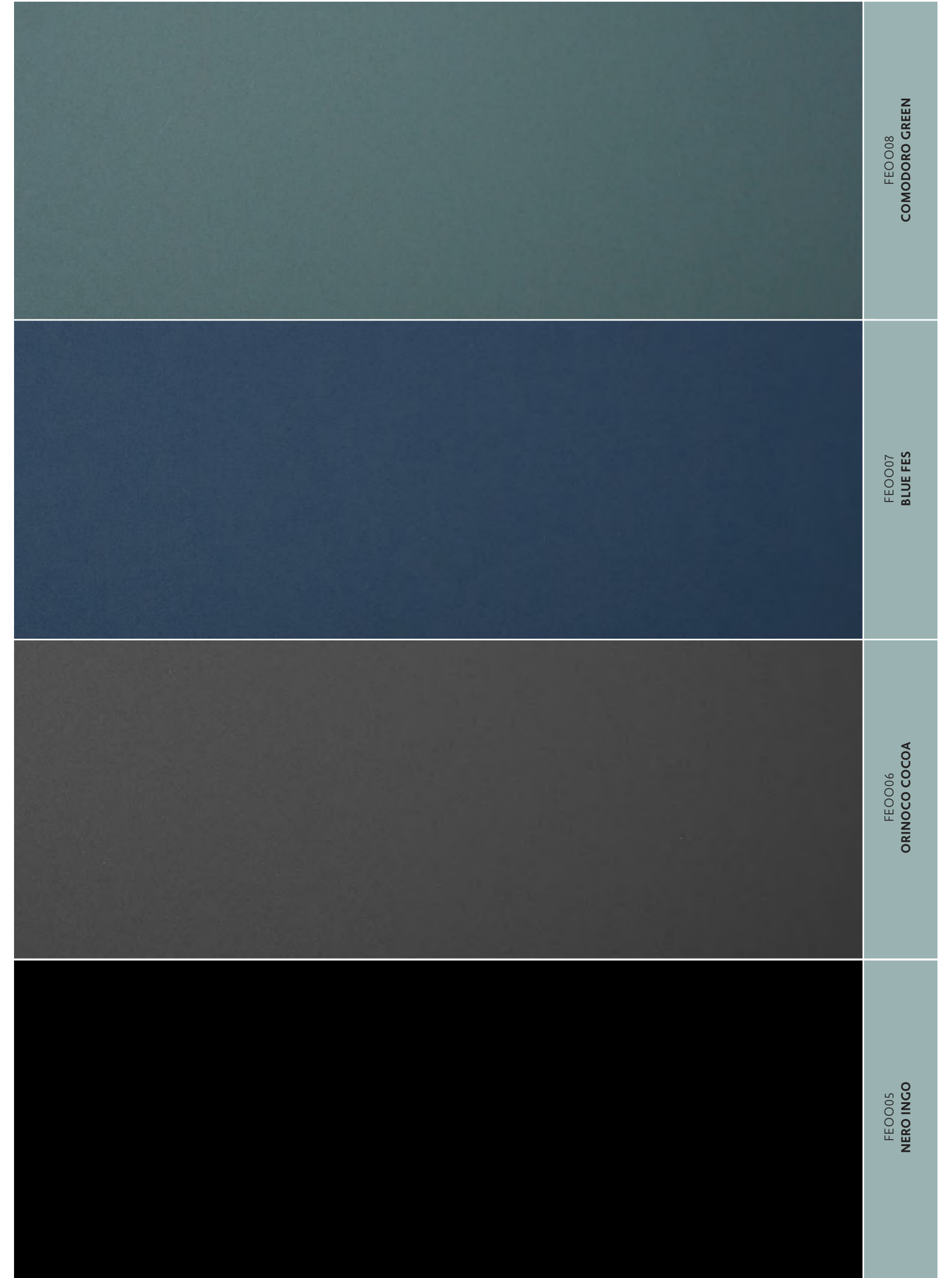
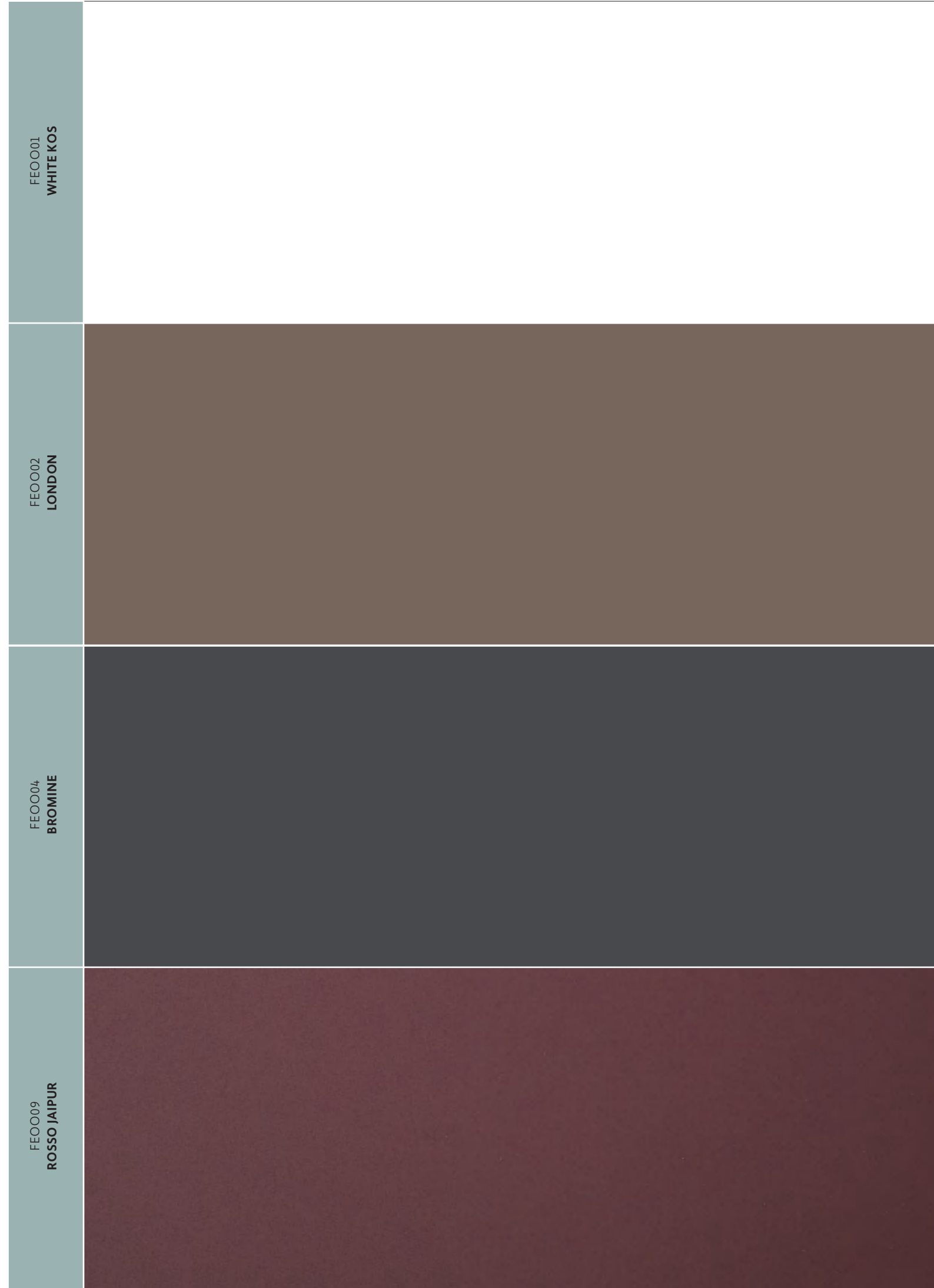

# WOOD

## THE PERFECTION OF NATURE

The most natural expression in your bathroom space.

## ash

**ASH** is a wood that grows on humid riverbanks and adapts to all types of climates, making it the hardwood par excellence for those looking for a solid and durable finish that is also beautiful and adaptable to different styles.

## oak

Whether it is Heartwood with its yellow-brown colour or Sapwood with its light tones, **OAK** is a wood that offers outstanding characteristics of resistance to humidity and high density as a material. The ideal wood for creating the most ambitious environments and designs in wood.

## walnut

From light brown to dark chocolate, sapwood can have greyish or even yellowish tones. It is one of the favourite dark woods, a natural elegance for the most exquisite tastes.



# ash

## WOOD

**ASH** is a wood that grows on humid riverbanks and adapts to all types of climates, making it the hardwood par excellence for those looking for a solid and durable finish that is also beautiful and adaptable to different styles.

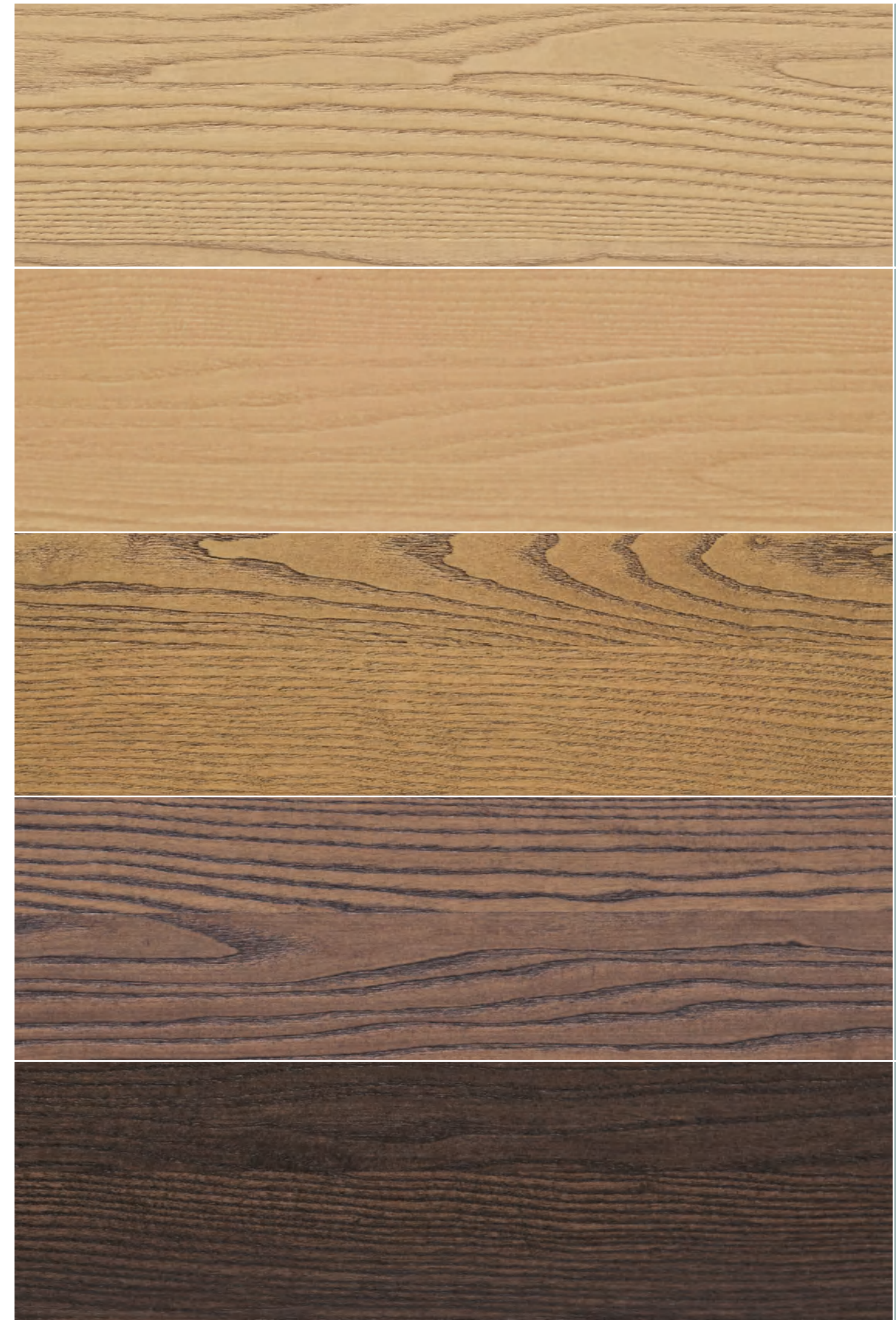

MAFO09  
ASH TREE VANILLA

MAFO12  
ASH TREE ALMOND

MAFO10  
ASH TREE HONEY

MAFO08  
ASH TREE HAZELNUT

MAFO11  
ASH TREE CHOCOLATE

# oak

## WOOD

Whether it is Heartwood with its yellow-brown colour or Sapwood with its light tones, **OAK** is a wood that offers outstanding characteristics of resistance to humidity and high density as a material. The ideal wood for creating the most ambitious environments and designs in wood.

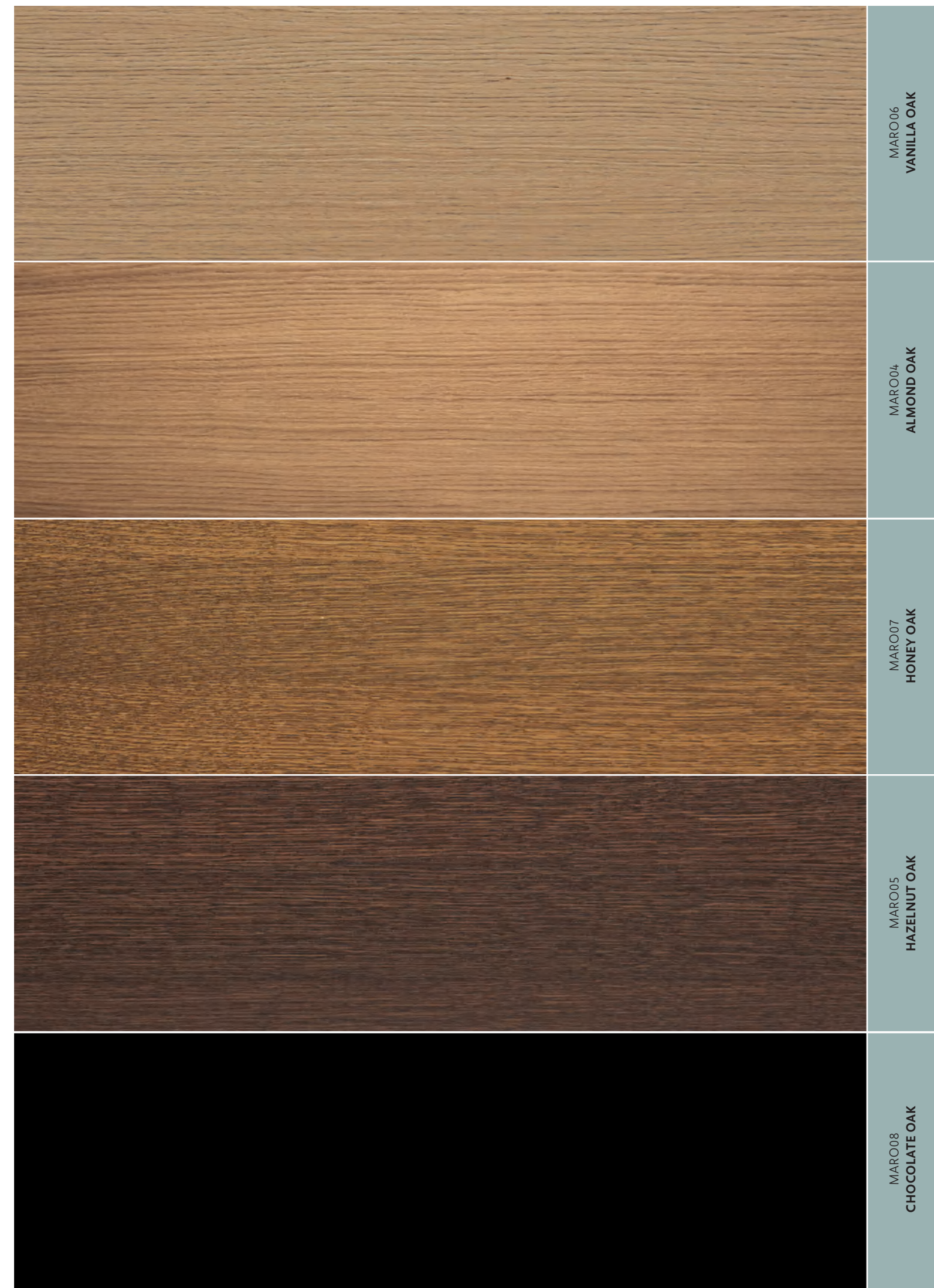

# walnut

## WOOD

From light brown to dark chocolate, sapwood can have greyish or even yellowish tones. It is one of the favourite dark woods, a natural elegance for the most exquisite tastes.

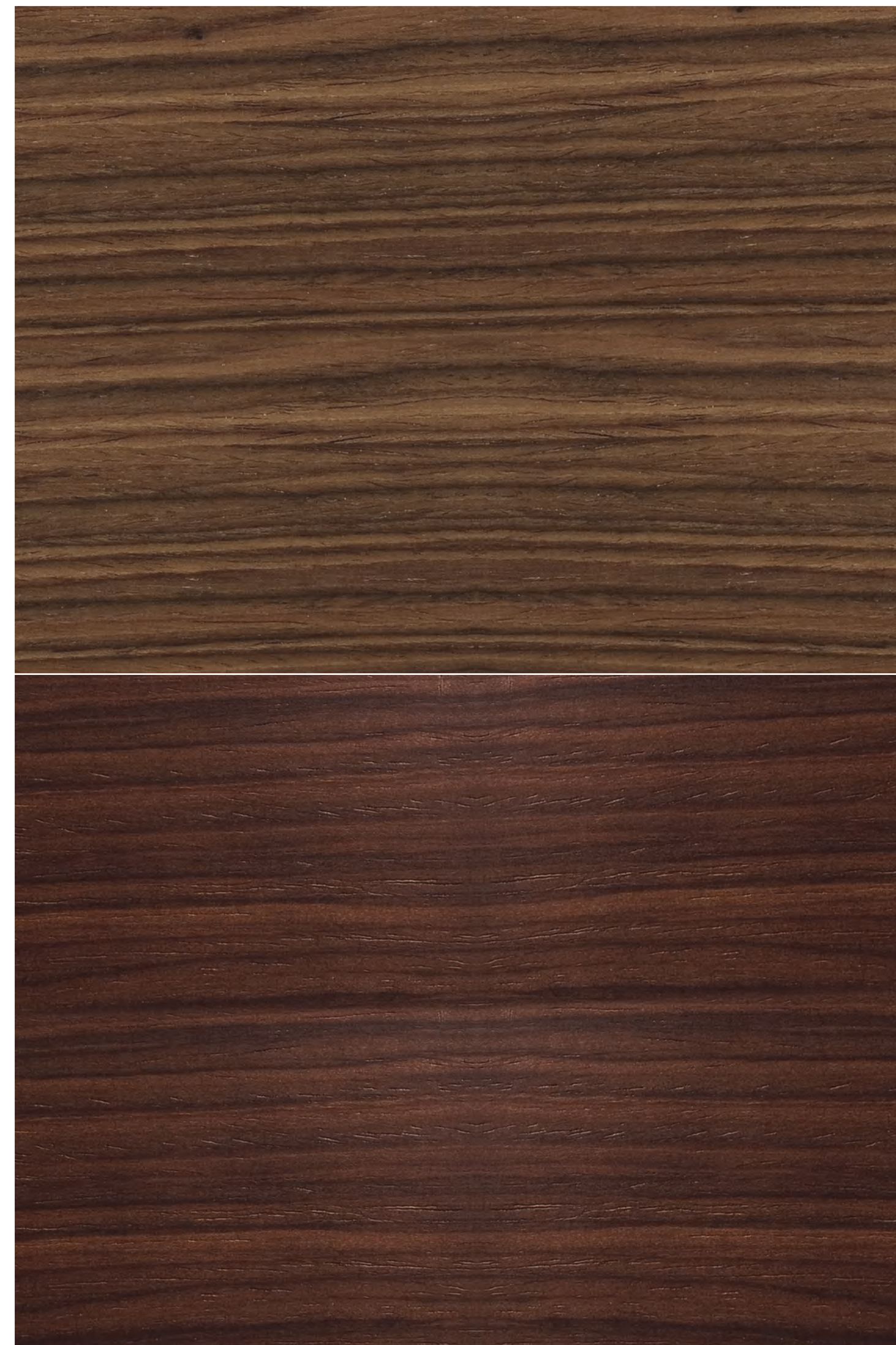

MANO01  
LIGHT WALNUT

MANO02  
DARK WALNUT



# LACQUER

**A WORLD OF COLOUR**

The essence of craftsmanship in a world of colours to choose from.



# SELECT MATT LACQUER

At KYRYA®, we have chosen 30 colours in a **matte finish** which enable us to provide a shorter delivery date and lower cost.



SX0001 RAL WHITE

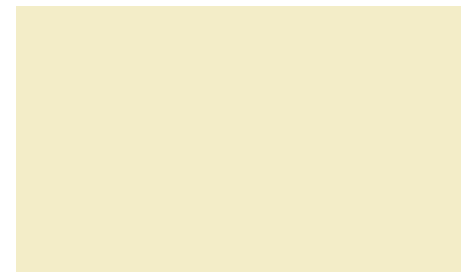

SX0009 RAL 1013



SX0006 RAL 9002



SX0026 RAL 1034



SX0029 RAL 3012

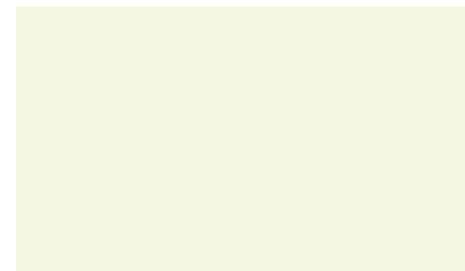

SX0002 RAL 9003



SX0010 RAL 7006

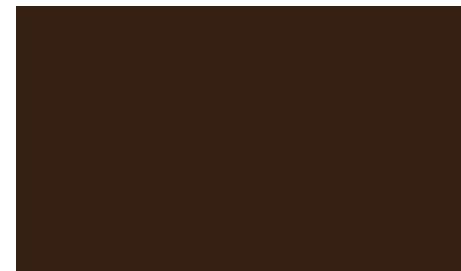

SX0011 RAL 8014



SX0017 RAL 1032



SX0018 RAL 2000



SX0003 RAL 7047



SX0004 RAL 7045

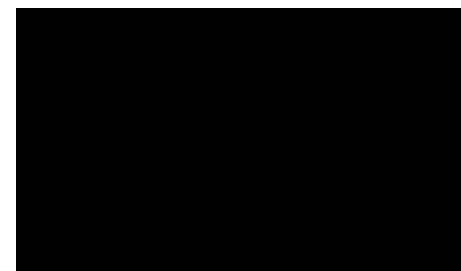

SX0005 RAL 7015



SX0019 RAL 2001



SX0020 RAL 3001



SX0030 RAL 7030



SX0007 RAL 7032



SX0008 RAL 7033



SX0021 RAL 3003



SX0015 RAL 3015



SX0025 RAL 6011



SX0013 RAL 6013



SX0028 RAL 6028



SX0016 RAL 4008



SX0022 RAL 5024



SX0012 RAL 6034



SX0027 RAL 5000

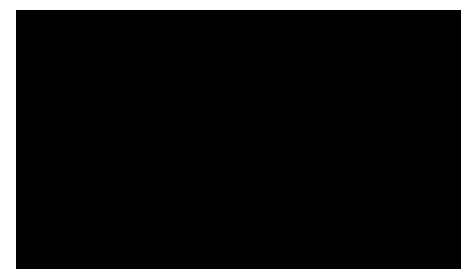

SX0014 RAL 9005



SX0023 RAL 5007



SX0024 RAL 5003

# RAL LACQUER (matt/polished/metallic)

KYRYA® offers you the possibility to choose any K5 RAL colour, simply use the Lacquer Select Matt price column and increase by 15% for a **matte** or **glossy** finish and increase by 20% for all **metallic** finishes.



RAL

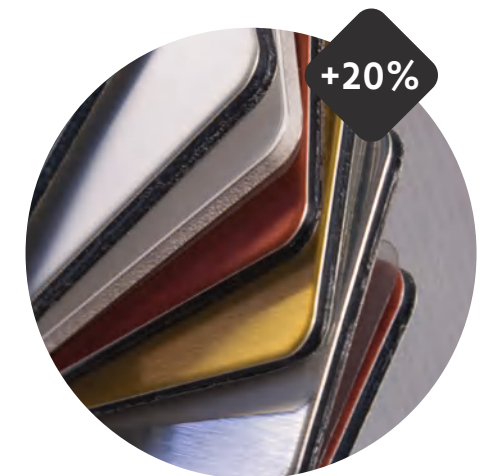

METALLIC

# HANDLES

	ANSO		CRISTINA		NEW STANDARD		DIANA		GINA		ANNA		FANNY	
	unit up to	handle measure.	unit up to	handle measure.	unit up to	handle measure.	unit up to	handle measure.	unit up to	handle measure.	unit up to	handle measure.	unit up to	handle measure.
horizontal (width**)	≤250	90	≤500	200	≤300	140	≤300	140	≤500	200	≤500	200	≤300	126
	>251	180	501-750	400	301-500	200	301-500	200	501-700	350	501-750	400	301-500	190
	-	-	≥751	600	501-700	320	501-700	320	≥701	600	≥751	600	≥501	350
	-	-	-	-	≥701	500	≥701	500	-	-	-	-	-	-
vertical (height**)	-	-	≤700	200	≤700	200	≤700	200	-	-	≤700	200	≤700	190
	-	-	701-1400	400	701-1400	320	701-1400	320	-	-	701-1400	400	≥701	350
	-	-	≥1401	600	≥1401	500	≥1401	500	-	-	≥1401	600	-	-

# CERAMIC WASHBASINS

	measurements		unit depth	displacement		handleless
	width	depth		left	right	
RIVER CENTRED	610/710/810	400	393	centred	-	P1/P2
RIVER CENTRED	610/710/810/910/1010/1210	460	455	centred	-	P1/P2
RIVER LEFT/RIGHT	910	460	455	305	-	P1/P2
	1010	460	455	360	-	P1/P2
RIVER DOUBLE	1210	460	455	305	305	P1/P2
	1410	460	455	355	355	P1/P2
CUADRO CENTRED	610/710/810/910/1010/1210	460	455	centred	-	P1/P2
CUADRO DOUBLE	1210	460	455	305	305	P1/P2
CUADRO LEFT/RIGHT	910	460	455	345	345	P1/P2
	1010	460	455	365	365	P1/P2
	1210	460	455	400	400	P1/P2
CUADRO MINI	610/710/810	360	355	centred	-	P2

# DURIAN® WASHBASINS

group	model	L basin	H basin	D basin	countertop depth	drawer height
B	ELBA 110	111/112	11/12.5	30/33	>46	>24
B	ELBA 40	40/42	11/12.5	30/33	>46	>24
B	ELBA 50	50/52	11/12.5	30/33	>46	>24
B	ELBA 60	60/62	11/12.5	30/33	>46	>24
B	ELBA SLIM 50	50/53	8.5/10.5	30/33	>46	>22
B	FLORENCE 40	40/44	11./13	30/34	>46	>24
	Straight handleless depth min. 47 cm.					
B	FLORENCE 50	50/54	11./13	30/34	>46	>24
	Straight handleless depth min. 47 cm.					
B	FLORENCE 60	60/62	11./15	30/35	>46	>28
	Straight handleless depth min. 47 cm.					
B	FLORENCE 80	80/84	14/17	30/35	>46	>28
	Straight handleless depth min. 47 cm.					
B	FLORENCE 100	101/105	14/17	30/35	>46	>28
	Straight handleless depth min. 47 cm.					
A	PISA FLAT 50	49/53	12./14	31/35	>48	>26
	Straight handleless depth min. 49 cm.					
A	PISA FLAT 59	59/63	12./14	31/35	>48	>26
	Straight handleless depth min. 49 cm.					
A	PISA FLAT 100	100/103	12./14	31/35	>48	>26
	Straight handleless depth min. 49 cm.					
A	FERRARA 50	50/53	11./13	31/34	>48	>24
	With or without cover. If no cover is indicated, the perimeter cover will be supplied on the left. Recommended tap location 17 cm from the start of the washbasin.					
A	FERRARA 59	59/63	11./13	31/34	>48	>24
	With or without cover. If no cover is indicated, the perimeter cover will be supplied on the left. Recommended tap location 17 cm from the start of the washbasin. Extra charge for cover.					
A	SICILIA 44	45/47	11./13	32/35	>48	>26
	Straight handleless depth min. 49 cm.					
A	SICILIA 50	49/53	11./13	32/35	>48	>26
	Straight handleless depth min. 49 cm.					
A	SICILIA 60	60/62	11./13	32/35	>48	>26
	Straight handleless depth min. 49 cm.					
A	59 MILANO	57/62	14/16	31/35	>48	>28
	Straight handleless depth min. 49 cm.					
A	BOLOGNA	49/52	11./12	30/34	>48	>24
B	VENECIA	59/65	10./13	31/33	>46	>24
	Straight handleless depth min. 47 cm.					
B	NEW SIENA	45/48	12.5/14	28/32	>46	>24
B	NEW CAPRI	50/54	10./14	29/33	>46	>24
A	NEW NAPOLI	32/36	11./13	32/36	>48	>24
	Straight handleless depth min. 49 cm.					
C	SIENA MINI	48/49	8.5/10.5	22.5/25	>40	>24
C	TURIN	33/35	9./10	25/27	>40	>24
	Straight handleless depth min. 41 cm.					
C	ELBA MINI	40/42.5	10./13	25/27.5	>40	>26
	Straight handleless depth min. 41 cm.					
C	FLORENCE MINI	40/44	11./14	21/25	>40	>26





# GENERAL TERMS AND CONDITIONS OF SALES

When making an order, customers accept our general terms and conditions of sales and the current price list.

## PRICES AND PRODUCT:

The prices shown in this price list are RRP's except for typographical errors. VAT and assembly are not included. This price list nullifies previous ones.

The company reserves the right to make partial or total technical modifications without notice to the products that appear in this pricelist in order to improve them.

The company cannot be held responsible for any change in the colour or for additions or changes to orders supplied at a later date.

The finishes shown in this price list may vary according to the finish and original colour of the material.

## ORDERS:

Orders are binding and only those received signed and dated in writing and including all the necessary information (finish, handle, structure, layout and measurements) for the whole order will be processed.

Once the order has been processed, a copy will be sent by e-mail for confirmation, a deadline of 24 hours being provided for modifications or corrections.

After 24 hours, no modifications or cancellations will be accepted.

All orders received will be processed individually and it is not possible to group orders together.

The delivery times shown on the order are an estimated date for products to leave our facilities.

The company cannot be held liable for compensation for delays to part or all of the delivery.

## PAYMENT CONDITIONS:

Payment as per previously agreed terms with the company.

Merchandise is the property of the company until full payment of the corresponding invoice has been made, the client acting as a depository.

## TRANSPORT AND MERCHANDISE:

Prices do not include transport, they are ex work.

The company will not accept the return of any goods and any delivery sent to our installations without prior consent shall be rejected and returned to the sender forthwith.

## GUARANTEE:

All our products are guaranteed against any manufacturing defect in accordance with current European legislation. The guarantee undertakes to repair or replace any defective elements.

The guarantee does not include damage occurring due to incorrect installation, manipulation or use.

No other complaints from clients shall be accepted.

Any complaint about products must be made in writing and accompanied by the corresponding purchase invoice.

## LAW COURTS:

When ordering, acceptance of each and every one of the terms and conditions of sales is implicit.

In the event of dispute, both parties shall be subject to the jurisdiction of the courts of the invoicing party.

# OBSERVATIONS

- 19 mm fronts and side panels.
- Extractable GRASS metallic drawers with soft close for units with depth over 32,5 cm.
- GRASS door hinges with soft close system.
- Polished high gloss and Select Matt Lacquers in the colours of the RAL chart +15%.
- All the frames of the furniture units are supplied with their own edge.
- All the non-decorative backs, shelves and structural elements are supplied in Charcoal Grey.
- Standard depth counter tops are KYRYA® models.
- Metallic laundry basket available for unit widths of 35 and 45 cm (See laundry basket units on page 43).
- The units include handle or handleless opening in the price, except those shown on page 16-29.
- Please specify in the order if the furniture is for installation between 3 walls.
- Permitted tolerance: Furniture  $\pm 2$  mm / Durian®  $\pm 3$  mm / Porcelain  $\pm 10$  mm / Pivstone®  $\pm 5$  mm.
- Depth of upper drawer in washbasin units, 5 cm shorter than the rest to facilitate installation.
- Washbasin units with height up to 45 cm and drawers include waste.
- Unless otherwise stated, the furniture is manufactured 10 mm shorter and 5 mm shallower than the countertop.
- Please ask about the viability of any article not shown in this price list.
- Countertops and washbasins do not include waste and supports.

# MEASUREMENTS

## SHELVES:

- High units from 40 to 59 cm include 1 shelf.
- High units up to 94 cm include 2 shelves.
- High units above 95 cm include 3 shelves.
- Columns above 139 cm include 4 shelves.
- Half column with door over 59 cm includes 1 shelf.
- Half column with door over 94 cm includes 2 shelves.

## DRAWERS:

- Minimum depth metallic drawer: 32,5 cm.
- Minimum drawer height: 16 cm (in the case of handleless system with rail or Anso, minimum 19 cm).
- Minimum drawer height for washbasins 24 cm.

# OPTIONS

- Washbasin unit height up to 88 cm with 10 cm plinth, supplement of 15%.
- Measurements not in catalogue subject to supplement of 10% per 10 cm.
- Change in proposed width layout, supplement of £102,17.
- Height and width of mirrors: 10% increase per 10 cm.
- Second waste: supplement of £65,02.
- Change in position or size of handles: supplement of £46,44.
- Clip with 3 positions per shelf: supplement of £37,15 per unit.
- Metallic lacquer: supplement of 20%.
- Wood or Lacquer according to sample.
- Non-standard countertop depth: supplement of £130,03.
- Washbasin units for washbasins not shown in this price list, supplement of £92,88.
- Mirrored doors: £86,00 per mirror in tall units and £130,03 in columns.
- Internal drawer dividers and internal drawer, (see page 63).
- Drawer runners with side glass panels (minimum drawer height 30 cm). Supplement of £42,05.
- Change to glass shelf, supplement of £53,87 (maximum width 50 cm).
- Special size pieces may have an extra charge of £176,47 for packaging.



---

---

---

---

---

---

---

---

---

---

---

---

---

---

---

---

---

---

---

---

---

---

---

---

---



w w w . k y r y a . e s

**CASCADA UK**

01482 667 451 • info@cascada.uk.com

**BUJIOL S.L.**

Pol. Centrovía - Nicaragua, 6 • 50198 La Muela • ZARAGOZA (Spain)  
(+34) 976 905 070 • export@kyrya.es